

Lexium 32 and Motors

Lexium 32 servo drives,
BMH and BSH servo motors

Catalog

March 2019



Quick access to product information

Get technical information about your product

References

Modicon M221 and M221 Book logic controllers
Modicon M221 logic controllers

References	Number of Logic inputs	Logic outputs	Analog inputs	Integrated communication ports (Ethernet, RS485, RJ45)	Reference	Weight (kg)
100-240 V ~ power supply	24 contacts, 24 V AC inputs, 16 inputs	7 relay outputs	2 x 0...10 V inputs	1	TM221C16R	0.345
24 V DC power supply	24 contacts, 24 V DC inputs, 16 inputs	7 relay outputs	2 x 0...10 V inputs	1	TM221C16R	0.345
24 V DC power supply	24 contacts, 24 V DC inputs, 16 inputs	7 relay outputs	2 x 0...10 V inputs	1	TM221C16R	0.345

TM221C16R
controller M221 16 IO relay

Download your TM221C16R datasheet

Change your selection

Discover other products & accessories

Discover your Schneider Electric tools

Characteristics | Dimensions Drawings | Mounting and Clearance | Connections and Schema | Performance Curves | Documents & Downloads

Main

- Range of product: Modicon M221
- Product or component type: Logic controller
- [It] rated supply voltage: 100...240 V AC
- Discrete input number: 9 discrete input conforming to IEC 61131-2 Type 1
- Analogue input number: 2 at input range: 0...10 V
- Discrete output type: Relay normally open
- Discrete output number: 7 relay
- Discrete output voltage: 5...125 V DC, 5...250 V AC
- Discrete output current: 2 A

Each commercial reference presented in this catalog contains a hyperlink. Click on it to obtain the technical information of the product:

- > Characteristics, Dimensions and drawings, Mounting and clearance, Connections and schemas, Performance curves
- > Product image, Instruction sheet, User guide, Product certifications, End of life manual

Find your catalog

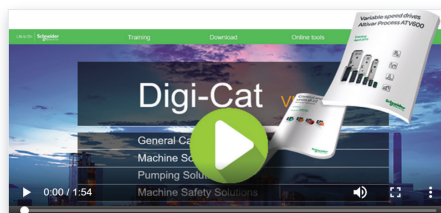

- > With just 3 clicks, you can reach the Industrial Automation and Control catalogs, in both English and French.
- > Download Digi-Cat with this [link](#)

Select your training



- > Find the right Training for your needs on our Global website
- > Locate the training center with the selector tool, using this [link](#)

General content

Lexium 32 and Motors

■ Lexium 32 servo drives

- Presentation of the range page 2
- Lexium 32 servo drive/BMH servo motor combinations page 6
- Lexium 32 servo drive/BSH servo motor combinations page 7
- Servo drives references page 8
- Dimensions, accessories and documentation page 10
- SoMove configuration software,
Configuration tools, memory card page 11
- Connection accessories pages 12 and 13
- Communication buses and networks
 - CANopen/CANmotion machine bus page 14
 - PROFIBUS DP V1 machine bus page 17
 - DeviceNet machine bus page 17
 - EtherNet/IP network page 18
 - EtherCAT machine bus page 19
 - PROFINET machine bus page 20
 - Modbus TCP network page 21
- Options
 - Encoder cards for Lexium 32M servo drives page 22
 - Safety card for Lexium 32M servo drives page 24
 - Input/output extension card for Lexium 32M servo drives page 25
 - Braking resistors page 26
 - Line chokes page 27
 - Integrated and additional EMC input filters page 28
 - Additional EMC input filters page 29
- Motor starters page 30
- Fuse protection page 31

■ BMH servo motors

- Presentation page 32
- Description page 33
- References page 34
- Dimensions page 35
- Connection components page 36
- Options: Integrated holding brake, Integrated encoder page 39

■ BSH servo motors

- Presentation page 40
- Description page 41
- References page 42
- Dimensions page 43
- Connection components page 44
- Options: Integrated holding brake, Integrated encoder page 47

■ Index

- Product reference index page 48

Lexium 32 and Motors

Lexium 32 Servo drives

Presentation of the range

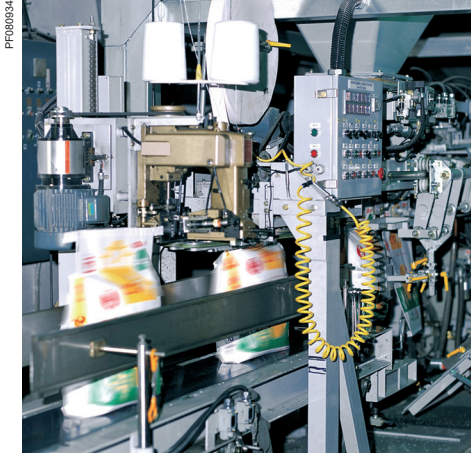

Lexium 32 servo drive controlling a packaging machine

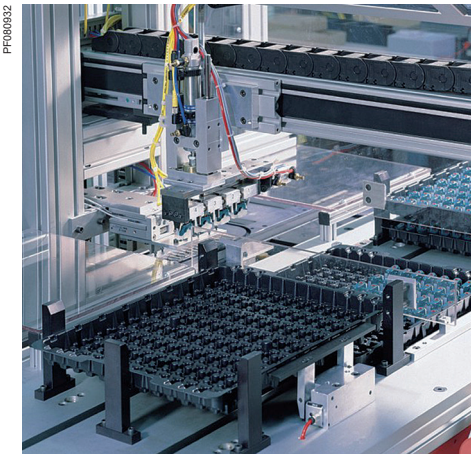

Lexium 32 servo drive controlling a handling machine

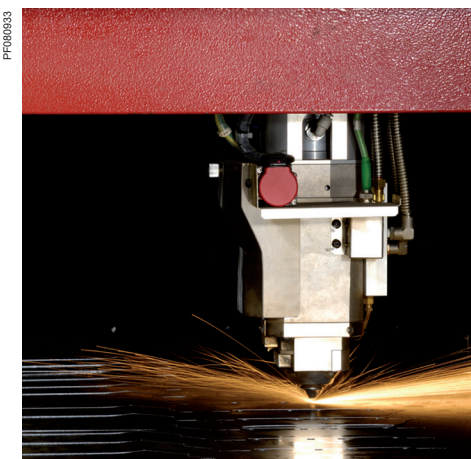

Lexium 32 servo drive controlling a materials processing machine

Presentation of the range

The Lexium 32 range of servo drives includes 4 servo drive models, LXM32C, LXM32A, LXM32M and LXM32S, associated with 2 servo motor ranges, BMH and BSH models for optimum use that can adapt to demands for high performance, power, and simplicity of use in motion control applications. It covers power ratings from 0.15 to 11 kW.

The Lexium 32 servo drive offer is designed to simplify the life cycle of machines. SoMove setup software, side-by-side mounting, and color-coded plug-in connectors, easily accessible on the front panel or on top of the servo drives, all help to make installation, setup, and maintenance easier. Maintenance is also quicker and cheaper thanks to the new duplication and backup tools, such as the memory card. [Please consult our catalog "SoMove, Setup software for motor control devices"](#).

Performance is improved through optimized motor control achieved through reduced vibration with automatic parameter calculation, a speed observer, and an additional band-stop filter. This optimization helps to increase machine productivity.

The compact size of the servo drives and servo motors provides maximum power in the minimum space, which helps to reduce overall machine size and costs.

Integrated communication or optional communication cards, depending on the model, as well as standard encoders, enable adaptation to numerous types of control system architecture for industry.

An integrated safety function and access to additional safety functions reduce design times and make it easier to comply with safety standards.

Applications for industrial machines

The Lexium 32 servo drive incorporates functions which are suitable for common applications, including:

- Printing: cutting, machines with position control, etc.
- Packaging and wrapping: cutting to length, rotary knife, bottling, capsuling, labeling, etc.
- Textiles: winding, spinning, weaving, embroidery, etc.
- Handling: conveying, palletization, warehousing, pick and place, etc.
- Transfer machines (gantry cranes, hoists), etc.
- Clamping, "on the fly" cutting operations (flying shear, printing, marking), etc.
- Materials processing

The offer

The Lexium 32 range of servo drives covers motor power ratings between 0.15 kW and 11 kW with three types of power supply:

- 110...120 V single-phase, 0.15 kW to 0.8 kW (**LXM32●●●●M2**)
- 200...240 V single-phase, 0.3 kW to 1.6 kW (**LXM32●●●●M2**)
- 208...480 V three-phase, 0.4 kW to 11 kW (**LXM32●●●●N4**)

Compliance with international standards and certifications

The entire range conforms to international standards IEC/EN 61800-5-1, IEC/EN 61800-3, is UL and CSA certified, and has been developed to meet the requirements of directives regarding protection of the environment (RoHS) as well as those of European Directives to obtain the CE mark.

Compliance with electromagnetic compatibility (EMC) requirements

The integration of a category C3 EMC filter in Lexium 32 servo drives and compliance with EMC simplify installation and make it very inexpensive to bring the device into conformity to obtain the CE mark.

Additional filters, available as an option, can be installed by the customer to reduce the level of conducted and radiated emissions (see page 28). They also enable the servo drive to be used with cable lengths of up to 100 metres/328 feet, to meet the requirements of applications in a wide variety of fields.

Accessories and options

External accessories and options such as braking resistors, line chokes, etc. enhance this offer.

Simplicity, from installation to maintenance

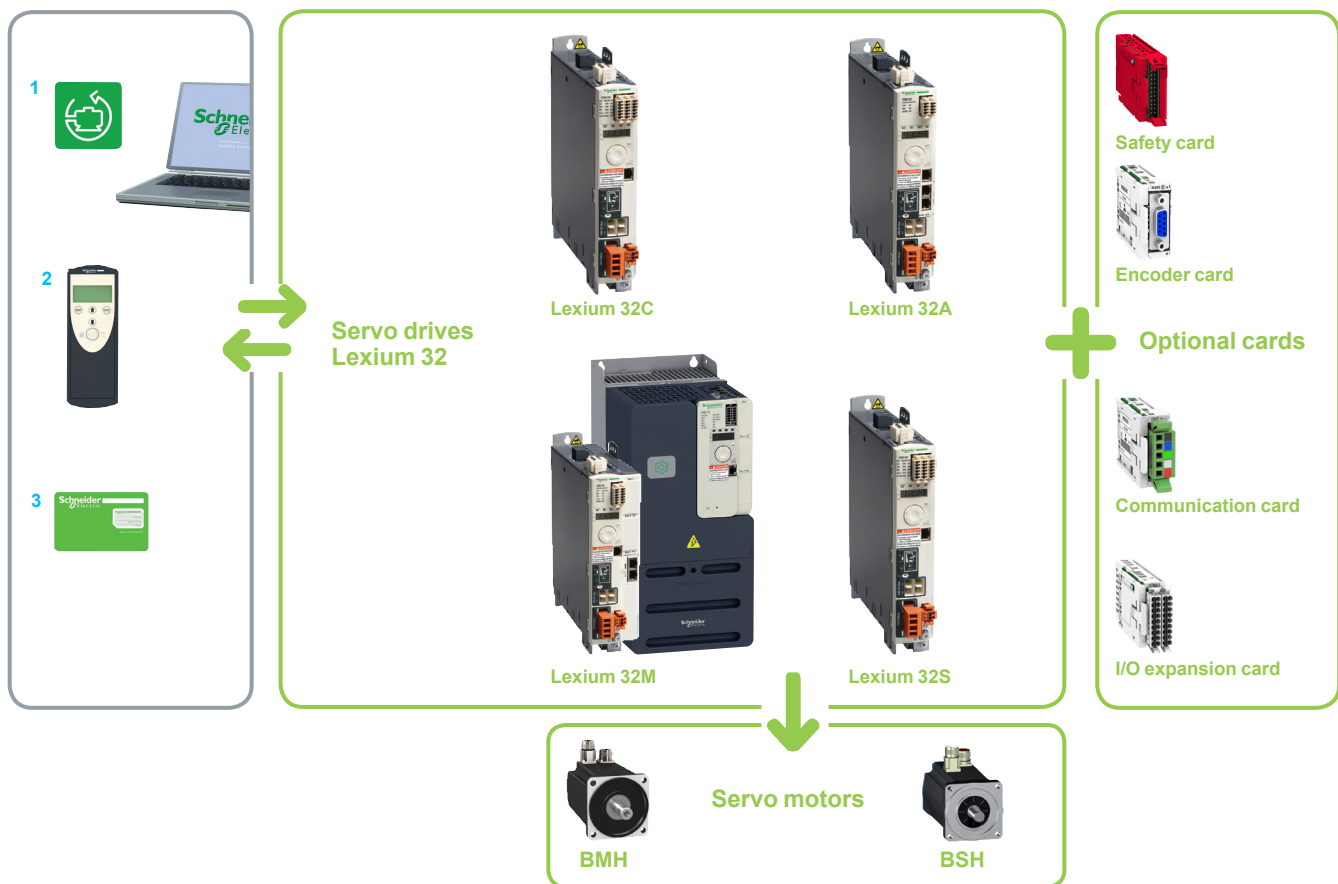

SoMove setup software 1

SoMove setup software is used in just the same way as it is on other Schneider Electric drives and starters, to configure and optimize control loops in automatic or manual mode using the Oscilloscope function and for maintenance of the Lexium 32 drive. It can be used with a Bluetooth® wireless connection (see page 11).

Multi-Loader tool 2

The Multi-Loader tool enables configurations to be copied from a PC or a servo drive and loaded onto another servo drive. The servo drives can be powered-down (see page 11).

Memory card 3

This stores the servo drive parameters. When replacing a Lexium 32 servo drive, this function helps to ensure immediate startup by removing the need to program the drive. This optimizes maintenance time and reduces costs (see page 11).

Auto-tuning

Adapted to each user, the 3 auto-tuning levels - automatic, semi-automatic, and expert - allow you to achieve a high level of machine performance, whatever the application.

Human-Machine Interface (HMI)

The display can be used to control and configure the servo drive, display states and detected faults, access parameters and modify them in manual mode using the navigation button.

Mounting and maintenance

Several Lexium 32 servo drives can be mounted side by side to save space. Connecting the servo drives is simplified by color-coded plug-in connectors, which are easily accessed on the front panel or on top of the drive.

Lexium 32 and Motors

Lexium 32 Servo drives

Presentation of the range

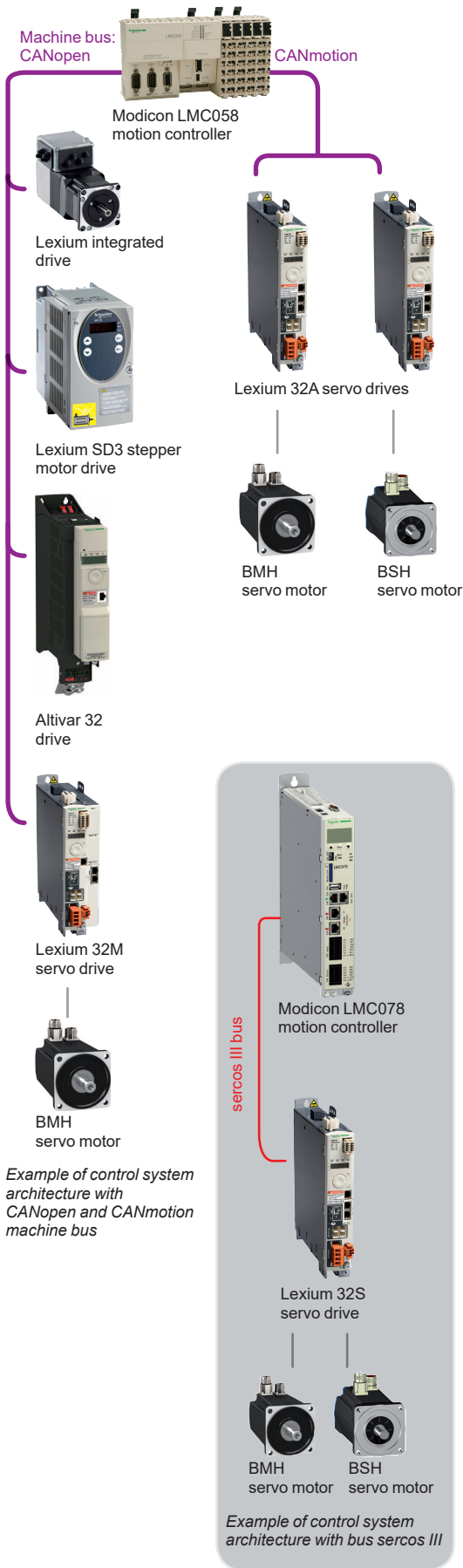

High performance

The Lexium 32 servo drive offer increases machine performance due to the following characteristics:

- **Overload capacity:** The high peak current (up to 4 times the direct current) increases the range of movement.
- **Power density:** The compact size of the servo drives offers maximum efficiency in a small space.
- **High bandwidth:** Better speed stability and faster acceleration improve the quality of control.
- **Motor control:** Less vibration, a speed observer, and an additional band-stop filter enhance the quality of control.

Design suitable for different control system structures

Its versatile specifications provide the Lexium 32 range of servo drives with excellent flexibility for integration in different control system structures.

Depending on the model, the Lexium 32 servo drive has logic or analog inputs and outputs as standard, which can be configured to adapt better to applications. It also has control interfaces for easy access to the various architecture levels:

- It has a control interface for control via pulse train.
 - It has a sercos interface (Lexium 32S).
 - It integrates a combined CANopen/CANmotion port for enhanced control system performance.
 - It can also be connected to the main industrial communication networks and buses using various communication cards.
- The following protocols are available: PROFIBUS DP V1, DeviceNet, EtherNet/IP, EtherCAT, PROFINET and Modbus TCP.

Dedicated safety functions

The Lexium 32 range of servo drives is an integral part of a control system's safety system, featuring as it does an integrated Safe Torque Off (STO) function, which helps to prevent unintended servo motor operation.

This function complies with standard IEC/EN 61508 level SIL3 governing electrical installations and the power drive systems standard IEC/EN 61800-1.

It simplifies the setup of installations requiring complex safety equipment and improves performance during maintenance operations by reducing the time required for servicing.

An additional eSM module is available for accessing enhanced safety functions.

BMH and BSH servo motors - dynamic and powerful

BMH and BSH servo motors are synchronous three-phase motors. They feature a SinCos Hiperface® encoder for automatic transmission of data from the servo motor to the servo drive and are available with or without a holding brake.

BMH servo motors

BMH servo motors are medium inertia motors. They are particularly suitable for high-load applications and allow the movement to be adjusted in a more robust manner.

This product offer covers a continuous stall torque range from 1.2 Nm to 100 Nm for nominal speeds from 1,200 to 5,000 rpm.

BSH servo motors

BSH servo motors satisfy requirements for precision and high dynamic performance, due to the low rotor inertia. They are compact, and offer a high power density.

This product offer covers a continuous stall torque range from 0.21 Nm to 33.4 Nm for nominal speeds from 2,500 to 9,000 rpm.

Lexium 32 and Motors

Lexium 32 Servo drives

Presentation of the range

Main functions					
Type of servo drive		LXM32C	LXM32A	LXM32M	LXM32S
Communication	Integrated	<input type="checkbox"/> Modbus serial link, <input type="checkbox"/> Pulse train, <input type="checkbox"/> ± 10 V	<input type="checkbox"/> Modbus serial link, <input type="checkbox"/> CANopen/CANmotion machine bus	<input type="checkbox"/> Modbus serial link, <input type="checkbox"/> Pulse train	<input type="checkbox"/> Modbus serial link, <input type="checkbox"/> sercos III
	As an option	–	–	<input type="checkbox"/> CANopen/CANmotion machine bus, <input type="checkbox"/> DeviceNet, <input type="checkbox"/> EtherNet/IP, <input type="checkbox"/> PROFIBUS DP V1, <input type="checkbox"/> EtherCAT, <input type="checkbox"/> PROFINET, <input type="checkbox"/> Modbus TCP	–
	Operating modes	<input type="checkbox"/> Manual mode (JOG), <input type="checkbox"/> Electronic gearbox, <input type="checkbox"/> Speed control, <input type="checkbox"/> Current control	<input type="checkbox"/> Homing, <input type="checkbox"/> Manual mode (JOG), <input type="checkbox"/> Speed control, <input type="checkbox"/> Current control, <input type="checkbox"/> Position control	<input type="checkbox"/> Homing, <input type="checkbox"/> Manual mode (JOG), <input type="checkbox"/> Motion sequence, <input type="checkbox"/> Electronic gearbox, <input type="checkbox"/> Speed control, <input type="checkbox"/> Current control, <input type="checkbox"/> Position control	<input type="checkbox"/> Homing, <input type="checkbox"/> Manual mode (JOG), <input type="checkbox"/> Speed control, <input type="checkbox"/> Current control, <input type="checkbox"/> Position control
	Functions	<input type="checkbox"/> Auto-tuning, <input type="checkbox"/> Monitoring, <input type="checkbox"/> Stopping, <input type="checkbox"/> Conversion	–	<input type="checkbox"/> Stop window, <input type="checkbox"/> Rapid entry of position values, <input type="checkbox"/> Rotary axes, <input type="checkbox"/> Position register	<input type="checkbox"/> Stop window, <input type="checkbox"/> Rapid entry of position values, <input type="checkbox"/> Rotary axes, <input type="checkbox"/> Position register
24 V ∴ logic inputs (1)		6, reassignable	4, reassignable	4, reassignable	4, reassignable
24 V ∴ capture inputs (1) (2)		–	1	2	2
24 V ∴ logic outputs (1)		5, reassignable	2, reassignable	3, reassignable	3, reassignable
Analog inputs		2	–	–	–
Pulse control input		1, configurable as: <input type="checkbox"/> RS 422 link <input type="checkbox"/> 5 V or 24 V push-pull <input type="checkbox"/> 5 V or 24 V open collector	–	1, configurable as: <input type="checkbox"/> RS 422 link <input type="checkbox"/> 5 V or 24 V push-pull <input type="checkbox"/> 5 V or 24 V open collector	–
ESIM PTO output		RS 422 link	–	RS 422 link	–
Human/Machine Interface (via integrated display terminal)		<input type="checkbox"/> Manual mode (positive/negative, fast/slow), <input type="checkbox"/> Auto-tuning, <input type="checkbox"/> Simple startup, <input type="checkbox"/> Display of information and detected errors	<input type="checkbox"/> Manual mode (positive/negative, fast/slow), <input type="checkbox"/> Auto-tuning, <input type="checkbox"/> Simple startup, <input type="checkbox"/> Display of information and detected errors, <input type="checkbox"/> Homing	–	–
Safety functions	Integrated	Safe Torque Off STO			
	As an option	–	–	<input type="checkbox"/> Safe Stop 1 (SS1) and Safe Stop 2 (SS2), <input type="checkbox"/> Safe Operating Stop (SOS), <input type="checkbox"/> Safe Limited Speed (SLS)	–
Sensor	Integrated	SinCos Hiperface® sensor			
	As an option	–	–	<input type="checkbox"/> Resolver encoder, <input type="checkbox"/> Analog encoder, <input type="checkbox"/> Digital encoder	–
Architecture	Control via	Logic or analog I/O	Motion controller via CANopen and CANmotion machine bus	Schneider Electric or third-party PLCs via communication buses and networks	Modicon LMC078 motion controller on sercos III network
Type of servo motor		BMH		BSH	
Application type		<input type="checkbox"/> High load , <input type="checkbox"/> With robust adjustment of the movement		<input type="checkbox"/> High dynamic response, <input type="checkbox"/> Power density	
Flange size		70, 100, 140 and 190mm (2.76, 3.94, 5.51 and 7.48 in.)		40, 55, 70, 100, and 140 mm (1.57, 2.17, 2.76, 3.94 and 5.51 in.)	
Continuous stall torque		1.2 to 100 Nm		0.21 to 33.4 Nm	
Encoder type	Single-turn SinCos	32,768 points/turn and 131,072 points/turn		131,072 points/turn	
	Multi-turn SinCos	32,768 points/turn x 4,096 turns and 131,072 points/turn x 4,096 turns		131,072 points/turn x 4,096 turns	
Degree of protection	Casing	IP 65 (IP 67 conformity kit as an option)			
	Shaft end	IP 54: horizontal mounting (IMB5) or vertical mounting (IMV1 with shaft end at the top) IP 50: vertical mounting IMV3 with shaft end at the bottom, or IP 65 (IP 67 conformity kit as an option)			

(1) Unless otherwise stated, the logic I/O can be used in positive logic (Sink inputs, Source outputs) or negative logic (Source inputs, Sink outputs).
(2) The capture inputs can be used as standard logic inputs.

Lexium 32 servo drive/BMH servo motor combinations							
Nominal operating point (1)				Stall torques	Servo drives		Servo motor
Nominal torque	Nominal speed	Nominal power	M_0 / M_{max} (2)	Reference	Continuous output current (rms)	Reference	Rotor inertia
Nm	rpm	W	Nm/Nm		A		kgcm ²
100...120 V single-phase supply voltage with integrated EMC filter							
1.35	2500	350	1.4/4.2	LXM32●D18M2	6	BMH0701T	0.59
2.3	2500	600	2.5/6.4	LXM32●D30M2	10	BMH0702T	1.13
3.1	2000	650	3.4/8.7	LXM32●D30M2	10	BMH0703T	1.67
3.3	2000	700	3.4/8.9	LXM32●D30M2	10	BMH1001T	3.2
3.5	2000	750	6/10.3	LXM32●D30M2	10	BMH1002T	6.3
200...240 V single-phase supply voltage with integrated EMC filter							
1.1	4000	450	1.4/4	LXM32●U90M2	3	BMH0701T	0.59
2.1	4000	900	2.5/7.4	LXM32●D18M2	6	BMH0702T	1.13
2.9	3000	900	3.4/10.2	LXM32●D18M2	6	BMH0703T	1.67
2.8	3000	900	3.4/10.2	LXM32●D18M2	6	BMH1001T	3.2
4.6	3000	1450	6/18.4	LXM32●D30M2	10	BMH1002T	6.3
5.6	2500	1450	8/23.5	LXM32●D30M2	10	BMH1003T	9.4
8.9	1500	1450	10.3/30.8	LXM32●D30M2	10	BMH1401P	16.5
208...480 V three-phase supply voltage with integrated EMC filter							
1.1	3000	350	1.2/4.2	LXM32●U60N4	1.5	BMH0701P	0.59
1.3	5000	700	1.4/4.2	LXM32●D12N4	3	BMH0701P	0.59
1.9	4000	800	3.3/10.8	LXM32●D12N4	3	BMH1001P	3.2
2.2	3000	700	2.5/7.4	LXM32●D12N4	3	BMH0702P	1.13
2.4	5000	1300	3.4/10.2	LXM32●D18N4	6	BMH0703P	1.67
3.1	4000	1300	3.4/10.2	LXM32●D18N4	6	BMH1001P	3.2
3.9	4000	1600	5.9/18.4	LXM32●D18N4	6	BMH1002P	6.3
6.2	4000	2600	8.4/25.1	LXM32●D30N4	10	BMH1003P	9.4
7.6	3000	2400	10.3/30.8	LXM32●D30N4	10	BMH1401P	16.5
12.1	3000	3800	16.8/50.3	LXM32●D72N4	24	BMH1402P	32.0
14.2	3000	4500	24/71.8	LXM32●D72N4	24	BMH1403P	47.5
18.4	2500	4800	30/77.7	LXM32●D72N4	24	BMH1901P	67.7
22.3	2500	5900	37.4/101	LXM32●D72N4	24	BMH1902P	130
36	1500	5700	43.2/123	LXM32●D72N4	24	BMH1903P	194
~ 480 V three-phase supply voltage with integrated EMC filter							
16.5	3000	5180	30/86.6	LXM32MD85N4	32	BMH1901P	67.7
29	2000	6070	48/115.5	LXM32MD85N4	32	BMH1902P	130
35	2000	7330	57.6/141.3	LXM32MD85N4	32	BMH1903P	194
16.5	3000	5180	30/89.7	LXM32MC10N4	40	BMH1901P	67.7
29	2000	6070	48/130.7	LXM32MC10N4	40	BMH1902P	130
37	2000	7750	65/162.7	LXM32MC10N4	40	BMH1903P	194
46.8	2000	9600	100/230	LXM32MC10N4	40	BMH1904P	276.7

(1) These values are given according to the supply voltage.

(2) M_0 : Continuous stall torque, M_{max} : Peak stall torque.

Lexium 32 and Motors

Lexium 32 Servo drives

Servo drive/BSH servo motor combinations

Lexium 32 servo drive/BSH servo motor combinations								
Nominal operating point (1)				Stall torques	Servo drives		Servo motor	
Nominal torque	Nominal speed	Nominal power	M_0 / M_{max} (2)	Reference	Continuous output current (rms)	Reference	Rotor inertia	
Nm	rpm	W	Nm/Nm		A		kgcm ²	
100...120 V single-phase supply voltage with integrated EMC filter								
0.49	3000	150	0.5/1.5	LXM32●U90M2	3	BSH0551T	0.06	
0.77	3000	250	0.8/1.9	LXM32●U90M2	3	BSH0552T	0.10	
1.14	3000	350	1.2/3.3	LXM32●D18M2	6	BSH0553T	0.13	
1.36	2500	350	1.4/3.5	LXM32●D18M2	6	BSH0701T	0.25	
2.07	2500	550	2.2/6.1	LXM32●D30M2	10	BSH0702T	0.41	
2.75	2500	700	3.3/6.3	LXM32●D30M2	10	BSH1001T	1.40	
200...240 V single-phase supply voltage with integrated EMC filter								
0.184	4000	77	0.21/0.8	LXM32●U45M2	1.5	BSH0401P	0.02	
0.184	4000	166	0.38/1.37	LXM32●U45M2	1.5	BSH0402P	0.04	
0.45	6000	300	0.5/1.4	LXM32●U45M2	1.5	BSH0551T	0.06	
0.74	6000	450	0.8/2.5	LXM32●U90M2	3	BSH0552T	0.10	
0.84	6000	550	1.2/3	LXM32●U90M2	3	BSH0553T	0.13	
0.94	5000	500	1.3/3.5	LXM32●D18M2	6	BSH0701T	0.25	
1.8	5000	950	2.2/7.2	LXM32●D18M2	6	BSH0702T	0.41	
2.1	4000	900	2.6/7.4	LXM32●D30M2	10	BSH0703T	0.58	
2.2	4000	900	2.7/7.5	LXM32●D30M2	10	BSH1001T	1.40	
3.7	4000	1500	5.8/16.4	LXM32●D30M2	1.5	BSH1002T	2.31	
208...480 V three-phase supply voltage with integrated EMC filter								
0.292	9000	152	0.21/0.8	LXM32●U60N4	1.5	BSH0401P	0.02	
0.292	9000	275	0.38/1.37	LXM32●U60N4	1.5	BSH0402P	0.04	
0.48	6000	300	0.5/1.5	LXM32●U60N4	1.5	BSH0551P	0.06	
0.65	6000	400	0.8/2.5	LXM32●U60N4	1.5	BSH0552P	0.10	
0.65	6000	400	1.05/3.5	LXM32●U60N4	1.5	BSH0553P	0.13	
1.32	5000	700	1.4/3.5	LXM32●D12N4	3	BSH0701P	0.25	
1.64	5000	850	2.2/7.6	LXM32●D12N4	3	BSH0702P	0.41	
2.44	5000	1300	3.1/11.3	LXM32●D18N4	6	BSH0703P	0.58	
2.7	4000	1100	3.3/9.6	LXM32●D18N4	6	BSH1001P	1.40	
4	4000	1700	5.8/18.3	LXM32●D18N4	6	BSH1002P	2.31	
6.3	3000	2000	8/28.3	LXM32●D30N4	10	BSH1003P	3.2	
8.3	2500	2100	10/37.9	LXM32●D30N4	10	BSH1004P	4.2	
9.5	2500	2500	11.1/27	LXM32●D30N4	10	BSH1401P	7.4	
12.3	3000	3900	19.5/59.3	LXM32●D72N4	24	BSH1402T	12.7	
12.9	3000	4100	27.8/90.2	LXM32●D72N4	24	BSH1403T	17.9	
19	2500	5000	33.4/103.6	LXM32●D72N4	24	BSH1404P	23.7	

(1) These values are given according to the supply voltage.

(2) M_0 : Continuous stall torque, M_{max} : Peak stall torque.



Lexium 32C, 32A, 32M and 32S servo drives						
Output current at 8 kHz		Nominal power at 8 kHz	Line current (2)	Max. prospective line Isc	Reference	Weight
Continuous (rms)	Peak (rms) (1)					
A	A	kW	A	kA		kg/lb
Single-phase supply voltage: 115 V ~ 50/60 Hz, with integrated EMC filter (3)						
1.5	3	0.15	2.9	1	LXM32CU45M2	1.600/3.527
					LXM32AU45M2	
					LXM32MU45M2	1.700/3.748
					LXM32SU45M2	
3	6	0.3	5.4	1	LXM32CU90M2	1.700/3.748
					LXM32AU90M2	
					LXM32MU90M2	1.800/3.968
					LXM32SU90M2	
6	10	0.5	8.5	1	LXM32CD18M2	1.800/3.968
					LXM32AD18M2	
					LXM32MD18M2	1.900/4.189
					LXM32SD18M2	
10	15	0.8	12.9	1	LXM32CD30M2	2.000/4.409
					LXM32AD30M2	
					LXM32MD30M2	2.100/4.630
					LXM32SD30M2	
Single-phase supply voltage: 230 V ~ 50/60 Hz, with integrated EMC filter (3)						
1.5	4.5	0.3	2.9	1	LXM32CU45M2	1.600/3.527
					LXM32AU45M2	
					LXM32MU45M2	1.700/3.748
					LXM32SU45M2	
3	9	0.5	4.5	1	LXM32CU90M2	1.700/3.748
					LXM32AU90M2	
					LXM32MU90M2	1.800/3.968
					LXM32SU90M2	
6	18	1	8.4	1	LXM32CD18M2	1.800/3.968
					LXM32AD18M2	
					LXM32MD18M2	1.900/4.189
					LXM32SD18M2	
10	30	1.6	12.7	1	LXM32CD30M2	2.000/4.409
					LXM32AD30M2	
					LXM32MD30M2	2.100/4.630
					LXM32SD30M2	

(1) Maximum value for 5 seconds
 (2) Without line choke (see page 27)
 (3) Additional EMC filters available as an option (see page 28)



LXM32M●●●●●

Lexium 32C, 32A, 32M and 32S servo drives (continued)						
Output current at 8 kHz		Nominal power at 8 kHz	Line current (2)	Max. prospective line Isc	Reference	Weight
Continuous (rms)	Peak (rms)(1)					
A	A	kW	A	kA		kg/lb
Three-phase supply voltage: 208 V ~ 50/60 Hz, with integrated EMC filter (3)						
1.8	6	0.35	1.8	5	LXM32CU60N4	1.700/ 3.748
					LXM32AU60N4	1.800/ 3.968
					LXM32MU60N4	1.800/ 3.968
					LXM32SU60N4	1.800/ 3.968
3.6	12	0.7	3.6	5	LXM32CD12N4	1.800/ 3.968
					LXM32AD12N4	1.900/ 4.189
					LXM32MD12N4	1.900/ 4.189
					LXM32SD12N4	2.000/ 4.409
6.2	18	1.2	6.2	5	LXM32CD18N4	2.000/ 4.409
					LXM32AD18N4	2.100/ 4.630
					LXM32MD18N4	2.100/ 4.630
					LXM32SD18N4	2.600/ 5.732
9.8	30	2	9.8	5	LXM32CD30N4	2.600/ 5.732
					LXM32AD30N4	2.700/ 5.952
					LXM32MD30N4	2.700/ 5.952
					LXM32SD30N4	4.800/ 10.582
21.9	72	5	21.9	5	LXM32CD72N4	4.800/ 10.582
					LXM32AD72N4	4.800/ 10.582
					LXM32MD72N4	4.800/ 10.582
					LXM32SD72N4	
Three-phase supply voltage: 480 V ~ 50/60 Hz, with integrated EMC filter (3)						
1.5	6	0.4	1.2	5	LXM32CU60N4	1.700/ 3.748
					LXM32AU60N4	1.800/ 3.968
					LXM32MU60N4	1.800/ 3.968
					LXM32SU60N4	1.800/ 3.968
3	12	0.9	2.4	5	LXM32CD12N4	1.800/ 3.968
					LXM32AD12N4	1.900/ 4.189
					LXM32MD12N4	1.900/ 4.189
					LXM32SD12N4	2.000/ 4.409
6	18	1.8	4.5	5	LXM32CD18N4	2.000/ 4.409
					LXM32AD18N4	2.100/ 4.630
					LXM32MD18N4	2.100/ 4.630
					LXM32SD18N4	2.600/ 5.732
10	30	3	7	5	LXM32CD30N4	2.600/ 5.732
					LXM32AD30N4	2.700/ 5.952
					LXM32MD30N4	2.700/ 5.952
					LXM32SD30N4	4.800/ 10.582
24	72	7	14.6	5	LXM32CD72N4	4.800/ 10.582
					LXM32AD72N4	4.800/ 10.582
					LXM32MD72N4	4.800/ 10.582
					LXM32SD72N4	
32	85	9	19.9	5	LXM32MD85N4	9.600/ 21.164
40	100	11	23.3	5	LXM32MC10N4	9.600/ 21.164

(1) Maximum value for 5 seconds

(2) Without line choke (see page 27)

(3) Additional EMC filters available as an option (see page 28)

LXM32MD85N4
LXM32MC10N4

Lexium 32 and Motors

Lexium 32 Servo drives

Dimensions, accessories, and documentation

Lexium 32C, 32A, 32M and 32S servo drives (continued)	
Dimensions (overall)	Width x Height x Depth mm/in.
LXM32CU60N4, CD12N4, CD18N4 LXM32AU60N4, AD12N4, AD18N4	48 x 270 x 237/ 1.89 x 10.63 x 9.33
LXM32MU60N4, MD12N4, MD18N4, MD30N4 LXM32CD30N4 LXM32AD30N4 LXM32SD60N4, SD12N4, SD18N4, SD30N4	68 x 270 x 237/ 2.68 x 10.63 x 9.33
LXM32D72N4	108 x 270 x 237/ 4.25 x 10.63 x 9.33
LXM32MD85N4, LXM32MC10N4	180 x 385 x 240/ 7.08 x 15.18 x 9.45

Servo drive name plate				
Description	Use	Dimensions mm/in.	Unit reference	Weight kg/lb
Name plate (sold in multiples of 50)	This contains information about the servo drive. To be clipped onto the top right-hand part of the servo drive	385 x 130/ 15.16 x 5.12	VW3M2501	–

Mounting accessories				
Description	Compatibility	Reference	Weight kg/lb	
EMC kit , This contains: <input type="checkbox"/> 1 EMC plate top <input type="checkbox"/> 1 EMC plate bottom <input type="checkbox"/> Screws and fixing collars <input type="checkbox"/> 1 user manual	LXM32MD85N4, LXM32MC10N4	VW3M2106	0.300/ 0.661	
Flush mounting kit For mounting the drive power section outside the enclosure This contains: <input type="checkbox"/> 4 fixing accessories <input type="checkbox"/> 1 metal frame <input type="checkbox"/> Screws and Seals <input type="checkbox"/> 1 user manual	LXM32MD85N4, LXM32MC10N4	VW3M2606	2.100/ 4.630	

Documentation
The documentation for the servo drives and servo motors is available on our website www.schneider-electric.com.

Lexium 32 and Motors

Lexium 32 Servo drives

SoMove setup software, Multi-Loader configuration tool, Memory card

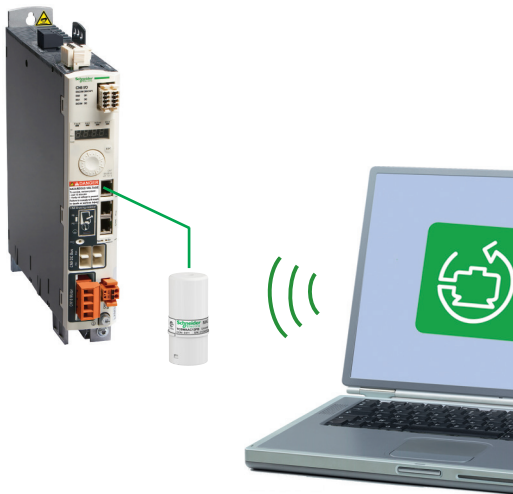

Configuration with the SoMove setup software via Bluetooth®

SoMove setup software

SoMove setup software is used on Lexium 32 servo drives in just the same way as it is on other Schneider Electric drives and starters, to configure, adjust, debug, and maintain the drive.

It communicates via a Bluetooth® wireless link with the servo drive, which is equipped with the Modbus-Bluetooth® adapter (VW3A8114).

It can be downloaded from our website www.schneider-electric.com or is available on the “Description of the Motion & Drives Offer” DVD ROM (VW3A8200).

For presentation, description, and references, please consult our catalog “SoMove, Setup software for motor control devices”.



Configuration of a Lexium 32 in its packaging with the VW3A8121 Multi-Loader tool + VW3A8126 cordset

Multi-Loader configuration tool

The Multi-Loader tool enables several configurations to be copied from a PC or a servo drive and loaded onto another servo drive.

The Lexium 32 servo drives do not need to be powered up.

References

Description	Reference	Weight kg/lb
Multi-Loader configuration tool Supplied with: <ul style="list-style-type: none"> ■ 1 cordset equipped with 2 RJ45 connectors ■ 1 cordset equipped with one type A USB connector and one mini B USB connector ■ 1 x 2 GB SD memory card ■ 1 x female/female RJ 45 adapter ■ 4 AA 1.5 V LR6 round batteries 	VW3A8121	–
Cordset for Multi-Loader tool For connecting the Multi-Loader tool to the Lexium 32 servo drive in its packaging. Equipped with: <ul style="list-style-type: none"> ■ A non-locking RJ45 connector with special mechanical catch on the drive end and ■ An RJ45 connector on the Multi-Loader end 	VW3A8126	–



Duplication of an application with the VW3M8705 memory card

Memory card

Description	Reference	Weight kg/lb
Memory card Used to store the parameters of the Lexium 32 servo drive. Another Lexium 32 servo drive can be commissioned immediately in the event of maintenance or duplication.	VW3M8705	–
Pack of 25 memory cards	VW3M8704	–

Lexium 32 and Motors

Lexium 32 Servo drives

Connection accessories

Connection accessories					
Replacement connectors					
Designation	For use with	Description	Reference	Weight	
Set of connectors	Lexium 32C	Comprising: ■ 4 connectors for the line supply ■ 3 connectors for the I/O ■ 2 connectors for the motor power supply ■ 1 connector for the holding brake	VW3M2201	–	
	Lexium 32A	Comprising: ■ 4 connectors for the line supply ■ 2 connectors for the I/O ■ 2 connectors for the motor power supply ■ 1 connector for the holding brake	VW3M2202	–	
	Lexium 32M	Comprising: ■ 4 connectors for the line supply ■ 2 connectors for the I/O ■ 2 connectors for the motor power supply ■ 1 connector for the holding brake	VW3M2203	–	
	Lexium 32 (all types)	Comprising: ■ 10 connectors for creating extension cordsets for the DC bus	VW3M2207	–	
Cordsets					
For use with	Description	Length m/ft	Unit reference	Weight	
Daisy chain connection of the DC bus	Between 1 Altivar Machine ATV320 drive (1) and 1 Lexium 32 servo drive: ATV320●●●●M2B/ LXM32●●●●M2 ATV320●●●●N4B/ LXM32●●●●N4	Equipped with 2 connectors (sold in lots of 5)	0.1/ 0.33	VW3M7101R01	–
Daisy chain connection or pulse control	For Lexium 32C and 32M servo drives (2)	Equipped with 2 RJ45 connectors	0.3/ 0.98	VW3M8502R03	0.025/ 0.055
			1.5/ 4.92	VW3M8502R15	0.062/ 0.137
		Equipped with 1 RJ45 connector and a free end	3/ 9.84	VW3M8223R30	–
Adapter for motor encoder cable	Replacement of a Lexium 05 servo drive with a Lexium 32 servo drive	Equipped with one 10-way Molex connector and one RJ45 connector (Lexium 32 servo drive end).	1/3,28	VW3M8111R10	–
	Replacement of a Lexium 15 servo drive with a Lexium 32 servo drive	Equipped with one 15-way female SUB-D connector and one RJ45 connector (Lexium 32 servo drive end).	1/3,28	VW3M8112R10	–
Cable and cordsets					
Designation	For use with	Length m/ft	Reference	Weight	
Daisy chain DC bus cable	Between 1 Altivar Machine ATV320 drive (1) and 1 servo drive Lexium 32 : ATV320●●●●M2B/LXM32●●●●M2 ATV320●●●●N4B/LXM32●●●●N4	15/ 49.21	VW3M7102R150	–	
sercos III cordsets for redundant ring	Preassembled cordsets with an RJ 45 connector at each end	Between Modicon LMC078 motion controller and LXM32S●●●M2, LXM32S●●●N4 servo drives	0.5/ 1.64	VW3E5001R005	–
			1/ 3.28	VW3E5001R010	–
			1.5/ 4.92	VW3E5001R015	–
			2/ 6.56	VW3E5001R020	–
			3/ 9.84	VW3E5001R030	–
			5/ 16.40	VW3E5001R050	–
			10/ 32.81	VW3E5001R100	–
			15/ 49.21	VW3E5001R150	–
			20/ 65.62	VW3E5001R200	–
			25/ 82.02	VW3E5001R250	–
	30/ 98.42	VW3E5001R300	–		
	40/ 131.23	VW3E5001R400	–		
	50/ 164.04	VW3E5001R500	–		

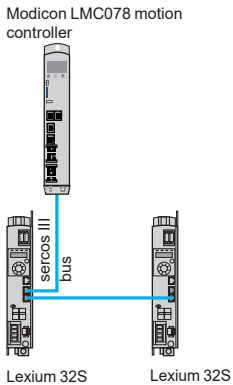

Example of architecture on sercos III with control by Modicon LMC078 motion controller



(1) Variable speed offer, consult catalog ref. DIA2ED2160311EN or our website www.schneider-electric.com
 (2) Except for LXM32MD85N4 and LXM32MC10N4 servo drives

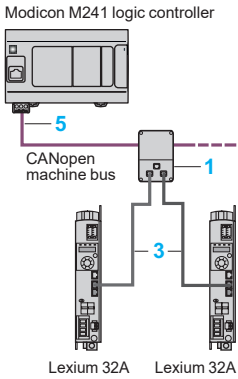

Example of architecture with control by Modicon M241 logic controller

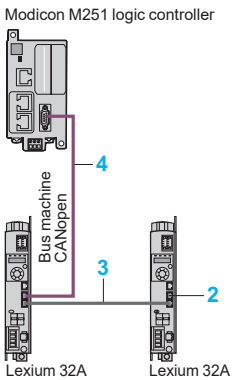

Example of architecture with control Modicon M251 logic controller

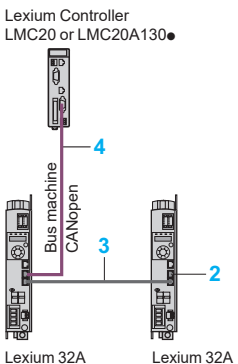

Example of architecture with control by Lexium Controller LMC

CANopen and CANmotion machine bus for Lexium 32A servo drives

Lexium 32A servo drives can be directly connected to the CANopen machine bus using an RJ45 connector. To simplify daisy chain connection, each servo drive is equipped with two connectors of this type (marked CN4 and CN5).

The communication function provides access to the servo drive's configuration, adjustment, control, and monitoring functions.

Used with a Lexium Controller motion controller, the CANmotion bus can be used to control motion for applications with up to 8 Lexium 32A servo drives.

Connection accessories (1)

Description	Use	Item no.	Reference	Weight kg/lb
IP 20 CANopen tap junction 2 RJ45 ports	Tap-off from trunk cable for RJ45 wiring	1	VW3CANTAP2	0.480/ 1.058
Line terminator 120 Ω (equipped with one RJ45 connector)	Connection to the RJ45 connector	2	TCSCAR013M120	0.009/ 0.020

Cordsets and cables (1)

Description	Use	Item no.	Length m/ft	Reference	Weight kg/lb		
						From	To
CANopen cordsets (1) equipped with 2 RJ45 connectors	VW3CANTAP2 tap junction LXM32A servo drive (CN4 and CN5 connectors)	3	0.3/ 0.98	VW3CANCARR03	0.320/ 0.705		
			1/ 3.28			VW3CANCARR1	0.500/ 1.102
CANopen cordsets (1) equipped with one 9-way female SUB-D connector with integrated line terminator and one RJ45 connector	Modicon M241/M251 logic controllers Motion controller Lexium Controller LMC20, LMC20A130●	4	1/ 3.28	VW3M3805R010	-		
			3/ 9.843			VW3M3805R030	-
CANopen cables (1) Standard cables, CE marking Low smoke, zero halogen Flame retardant (IEC 60332-1)	PLC	5	50/ 164.04	TSXCANCA50	4.930/ 10.869		
			100/ 328.08			TSXCANCA100	8.800/ 19.401
			300/ 984.25			TSXCANCA300	24.560/ 54.145
			50/ 164.04			TSXCANCB50	3.580/ 7.893
CANopen cables (1) UL certification, CE marking Flame retardant (IEC 60332-2)	PLC	5	100/ 328.08	TSXCANCB100	7.840/ 17.284		
			300/ 984.25			TSXCANCB300	21.870/ 48.215
			50/ 164.04			TSXCANCD50	3.510/ 7.738
CANopen cables (1) Cables for harsh environments (2) or mobile installation, CE marking Low smoke, zero halogen Flame retardant (IEC 60332-1)	PLC	5	100/ 328.08	TSXCANCD100	7.770/ 17.130		
			300/ 984.25			TSXCANCD300	21.700/ 47.840
			50/ 164.04			TSXCANCA50	4.930/ 10.869

(1) For other CANopen machine bus connection accessories, please consult our website www.schneider-electric.com.

(2) Harsh environment:

- Resistance to hydrocarbons, industrial oils, detergents, solder splashes
- Relative humidity up to 100%
- Saline atmosphere
- Significant temperature variations
- Operating temperature between - 10 °C/+ 14 °F and + 70 °C/+ 158 °F

Lexium 32 and Motors

Lexium 32 Servo drives

CANopen/CANmotion machine bus

Lexium 32A servo drives integrate the CANopen communication protocol as standard (see page 13).

If one of the communication cards (available as options) is added, the Lexium 32M servo drive can be connected to the following communication buses and networks:

- CANopen and CANmotion machine bus
- PROFIBUS DP V1 fieldbus
- DeviceNet fieldbus
- EtherNet/IP network
- EtherCAT fieldbus
- PROFINET fieldbus
- Modbus TCP network.

The Lexium 32M servo drive can only take one communication card.

CANopen and CANmotion machine bus

Presentation

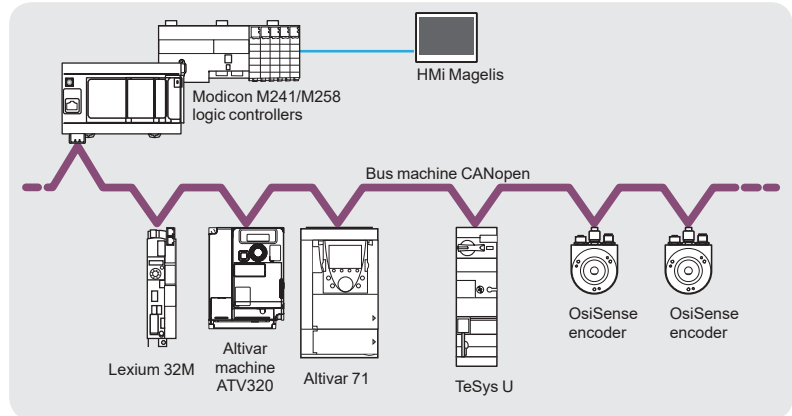

The CANopen machine bus is specifically designed for integration in control system architectures. It provides openness and interoperability for various devices (drives, motor starters, smart sensors, etc.).

A tiered CANopen connectivity solution reduces costs and optimizes the creation of the control system architecture, providing:

- Reduced cabling time
- Greater reliability of the load
- Flexibility should you need to add or remove equipment

It is very easy to set up.

The same communication card provides access to either the CANopen or CANmotion machine bus.

The characteristics of the cards are available on our website www.schneider-electric.com.

Optimized solution for connection to the CANopen/CANmotion machine bus

To simplify the setup of Lexium 32M servo drives, 3 communication cards are available, each with different connectors:

- CANopen/CANmotion daisy chain card with connection to the bus via 2 RJ45 connectors, providing an optimized solution for daisy chain connection to the CANopen machine bus (see page 15)
- CANopen/CANmotion card with connection to the bus via screw terminals (see page 15)
- CANopen/CANmotion card with connection to the bus via 9-way male SUB-D connector (see page 16)



Installing the CANopen communication card VW3A3608

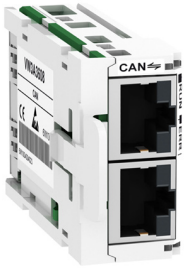

VW3A3608 CANopen communication card

Modicon M251 logic controller **or** Lexium Controller LMC

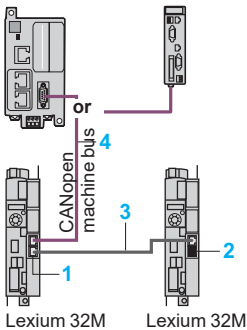

Lexium 32M Lexium 32M
Daisy chain connection with VW3A3608 CANopen card



VW3A3628 CANopen communication card

Modicon M241/M258 logic controllers

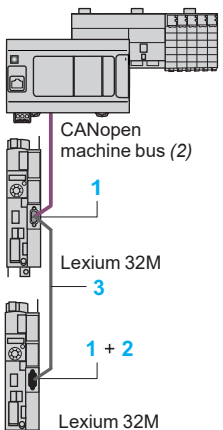

Example of connecting Lexium 32M with VW3A3628 card

CANopen/CANmotion machine bus: connection via RJ45 connector

CANopen/CANmotion daisy chain communication card

Description	Type of port	Item no.	Unit reference	Weight kg/lb
CANopen/CANmotion daisy chain card for Lexium 32M servo drives	2 RJ45 connectors	1	VW3A3608	-

Connection accessories for VW3A3608 CANopen daisy chain card

CANopen line terminator (1)	With RJ45 connector	2	TCSCAR013M120	0.009/ 0.020
CANopen IP 20 tap junctions	2 RJ45 connectors	-	VW3CANTAP2	0.250/ 0.551

Cordsets for VW3A3608 CANopen/CANmotion daisy chain card

Description	Use		Item no.	Length m/ft	Reference	Weight kg/lb
	From	To				
CANopen cordsets equipped with one RJ45 connector at each end	LXM32A servo drive	VW3A3608 card	3	0.3/ 0.98	VW3CANCARR03	0.320/ 0.705
	LXM32M servo drive	LXM32A servo drive				
	VW3A3608 card	LXM32M servo drive				
CANopen cordsets equipped with one 9-way female SUB-D connector with integrated line terminator and one RJ45 connector	M241 logic controller	VW3A3608 card	4	1/ 3.28	VW3M3805R010	-
	Lexium Controller: LMC20, LMC20A130	LXM32A servo drive				
		LXM32M servo drive				
				3/ 9.84	VW3M3805R030	-

CANopen/CANmotion machine bus: connection via screw terminals

CANopen/CANmotion communication card

Description	Type of port	Item no.	Unit reference	Weight kg/lb
CANopen/CANmotion card for Lexium 32M servo drives	One 5-way screw terminal block	1	VW3A3628	-

Connection accessory for VW3A3628 CANopen/CANmotion communication card

CANopen line terminator (1)	Stripped wires for screw terminal connector	2	TCSCAR01NM120	-
-----------------------------	---	---	---------------	---

Connection cables for VW3A3628 CANopen/CANmotion communication card

Description	Use		Item no.	Length m/ft	Reference	Weight kg/lb
	From	To				
CANopen cables Standard cables, CE marking Low smoke zero halogen Flame retardant (IEC 60332-1)	Programmable controller	VW3A3628 card	3	50/ 164.04	TSXCANCA50	4.930/ 10.869
				100/ 328.08	TSXCANCA100	8.800/ 19.401
				300/ 984.25	TSXCANCA300	24.560/ 54.145
CANopen cables UL certification, CE marking Flame retardant (IEC 60332-2)	Programmable controller	VW3A3628 card	3	50/ 164.04	TSXCANCB50	3.580/ 7.893
				100/ 328.08	TSXCANCB100	7.840/ 17.284
				300/ 984.25	TSXCANCB300	21.870/ 48.215
CANopen cables Cable for harsh environment (3) or mobile installation, CE marking Low smoke zero halogen Flame retardant (IEC 60332-1)	Programmable controller	VW3A3628 card	3	50/ 164.04	TSXCANCD50	3.510/ 7.738
				100/ 328.08	TSXCANCD100	7.770/ 17.130
				300/ 984.25	TSXCANCD300	21.700/ 47.840

(1) Sold in lots of 2.

(2) Cable dependent on the type of controller or PLC; please refer to the corresponding catalog.

(3) Harsh environment: - resistance to hydrocarbons, industrial oils, detergents, solder splashes
- relative humidity up to 100% - saline atmosphere
- significant temperature variations, operating temperature between - 10 °C/+ 14 °F and + 70 °C/+ 158 °F

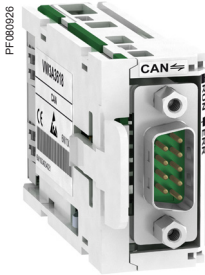

VW3A3618 CANopen communication card

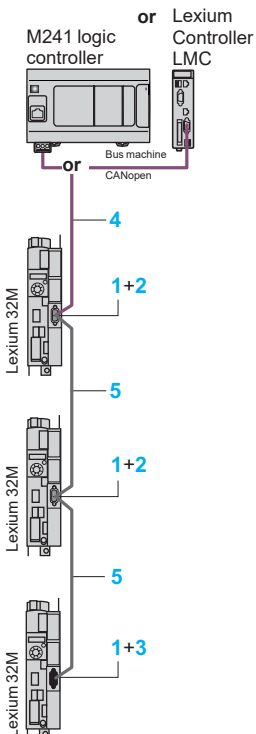

Example of connection to the CANopen machine bus with VW3A3618 card

CANopen/CANmotion machine bus: connection via SUB-D connector

CANopen/CANmotion communication card

Description	Type of port	Item no.	Reference	Weight kg/lb
CANopen/CANmotion card for Lexium 32M servo drives	One 9-way male SUB-D connector	1	VW3A3618	–

Connection accessories for VW3A3618 CANopen/CANmotion card

Description	Type of port	Item no.	Unit reference	Weight kg/lb
9-way female SUB-D connector with screw terminals. Line termination switch that can be deactivated	–	2	VW3M3802	–
CANopen line terminator (1)	Stripped wires for screw terminal connector	3	TCSCAR01NM120	–
CANopen IP20 connectors, 9-way female SUB-D. Line termination switch that can be deactivated	Straight	–	TSXCANKCDF180T	0.049/0.108
	Right angle elbow	–	TSXCANKCDF90T	0.046/0.101
	Right angle elbow with 9-way SUB-D for connecting PC or diagnostics tool	–	TSXCANKCDF90TP	0.051/0.112

Cordsets for VW3A3618 CANopen/CANmotion card

Description	Use		Item no.	Length m/ft	Reference	Weight kg/lb
	From	To				
CANopen IP 20 cordsets equipped with one 9-way female SUB-D 9 connector at each end. Standard cables, Cc marking Low smoke zero halogen Flame retardant (IEC 60332-1)	Lexium Controller: LMC20, LMC20A130	VW3A3618 card	4	0.3/0.98	TSXCANCADD03	0.091/0.201
				1/3.28	TSXCANCADD1	0.143/0.315
				3/9.84	TSXCANCADD3	0.295/0.650
				5/16.40	TSXCANCADD5	0.440/0.970
CANopen IP 20 cordsets equipped with one 9-way female SUB-D 9 connector at each end. Standard cables, UL certification, Cc marking Flame retardant (IEC 60332-2)	Lexium Controller: LMC20, LMC20A130	VW3A3618 card	4	0.3/0.98	TSXCANCBDD03	0.086/0.190
				1/3.28	TSXCANCBDD1	0.131/0.289
				3/9.84	TSXCANCBDD3	0.268/0.591
				5/16.40	TSXCANCBDD5	0.400/0.882

CANopen/CANmotion machine bus: other connection accessories

Description	Use		Item no.	Length m/ft	Reference	Weight kg/lb
	From	To				
CANopen cables Standard cables, Cc marking Low smoke zero halogen Flame retardant (IEC 60332-1)	VW3M3802 connector	VW3M3802 connector	5	50/164.04	TSXCANCA50	4.930/10.869
	TSXCANKCDF90T connector	TSXCANKCDF90T connector		100/328.08	TSXCANCA100	8.800/19.401
	M241/M238 logic controllers	M241/M238 logic controllers		300/984.25	TSXCANCA300	24.560/54.145
CANopen cables UL certification, Cc marking Flame retardant (IEC 60332-2)	VW3M3802 connector	VW3M3802 connector	5	50/164.04	TSXCANCB50	3.580/7.893
	TSXCANKCDF90T connector	TSXCANKCDF90T connector		100/328.08	TSXCANCB100	7.840/17.284
	M241/M238 logic controllers	VW3CANTAP2 tap junction		300/984.25	TSXCANCB300	21.870/48.215
CANopen cables Cable for harsh environment (2) or mobile installation, Cc marking Low smoke zero halogen Flame retardant (IEC 60332-1)	VW3M3802 connector	VW3M3802 connector	5	50/164.04	TSXCANCD50	3.510/7.738
	TSXCANKCDF90T connector	TSXCANKCDF90T connector		100/328.08	TSXCANCD100	7.770/17.130
	M241/M238 logic controllers	VW3CANTAP2 tap junction		300/984.25	TSXCANCD300	21.700/47.840

(1) Sold in lots of 2.

(2) Harsh environment: - resistance to hydrocarbons, industrial oils, detergents, solder splashes

- relative humidity up to 100% - saline atmosphere

- significant temperature variations, operating temperature between - 10 °C/+ 14 °F and + 70 °C/+ 158 °F

PROFIBUS DP V1 fieldbus

Presentation

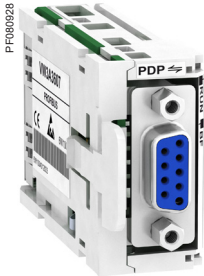

VW3A3607 PROFIBUS DP V1 communication card

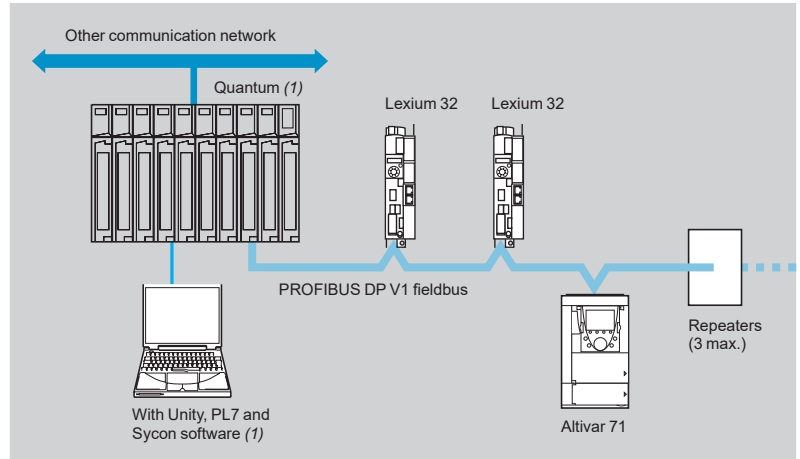

PROFIBUS DP is a fieldbus for industrial communication. The Lexium 32M servo drive is connected to the PROFIBUS DP V1 fieldbus via the VW3A3607 communication card. Other devices can be connected to the PROFIBUS DP V1 bus such as PLCs (1), STB I/O (2), Altivar variable speed drives (3), Osicoder rotary encoders (4), etc.

Reference

Description	For use with	Type of port	Reference	Weight kg/lb
PROFIBUS DP V1 card	Lexium 32M servo drives	One 9-way female SUB-D connector	VW3A3607	0.140/ 0.309

DeviceNet fieldbus

Presentation

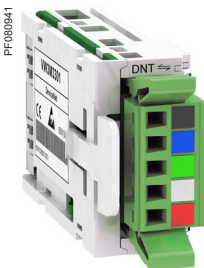

VW3M3301 DeviceNet communication card

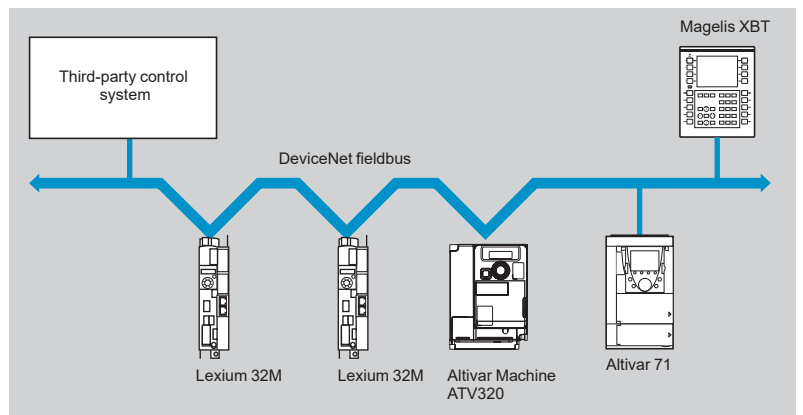

The DeviceNet fieldbus is used in industry to manage a large number of devices remotely. Connection to the DeviceNet fieldbus allows Lexium 32M servo drives to standardize motion control solutions, while remaining independent of the system controlling the machine.

Reference

Description	For use with	Type of port	Profiles supported	Reference	Weight kg/lb
DeviceNet card (supported by firmware version ≤ V1.20)	Lexium 32M servo drive	One removable screw connector, 5 contacts with 5.08 pitch	CIP motion profile Profile compatible with PLCopen libraries	VW3M3301	—

(1) Please refer to "Automation platform Modicon Quantum" catalog Ref. [MKTED2120701EN](#)
 (2) Please refer to "IP 20 distributed inputs/outputs Modicon STB" catalog Ref [MKTED2130401EN](#)
 (3) Please refer to "Altivar Machine ATV320 variable speed drives" catalog Ref [DIA2ED2160311EN](#)
 (4) Please refer to Sensors catalogs on the website www.tesensors.com.

EtherNet/IP network

Presentation

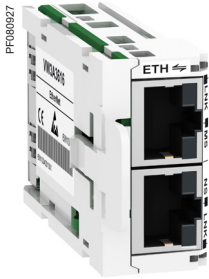

VW3A3616 EtherNet/IP communication card

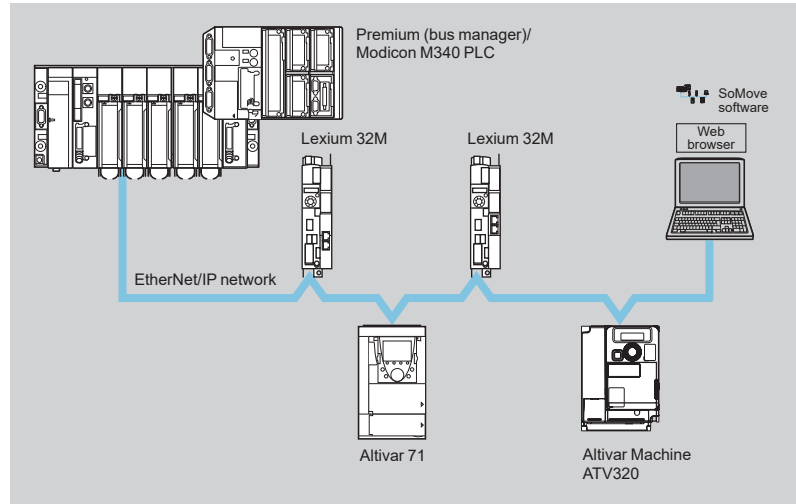

The EtherNet/IP network is a protocol specially designed for industrial environments. It uses the widely implemented Ethernet protocols TCP (Transmission Control Protocol) and IP (Internet Protocol), thus offering an integrated transparent connection system to the company network.

Thanks to its high speed, the network no longer restricts the application's performance. It is the pre-eminent open protocol and supports the following types of communication:

- Web pages
- File transfers
- Messaging

Reference

Description	For use with	Type of port	Reference	Weight kg/lb
EtherNet/IP card ■ 10/100 Mbps, half and full duplex ■ Embedded Web server	Lexium 32M servo drives	2 RJ45 connectors	VW3A3616	0.300/ 0.661

EtherNet/IP network connection accessories

Description	Type of port	Length m/ft (1)	Reference	Weight kg/lb
ConneXium cordsets (conforming to EIA/TIA-568, category 5 and IEC1180/EN50173, class D, standards)				
Straight shielded twisted pair cordsets	2 RJ45 connectors	2/ 6.56	490NTW00002	—
		5/ 16.40	490NTW00005	—
		12/ 39.37	490NTW00012	—
Crossed shielded twisted pair cordsets	2 RJ45 connectors	5/ 16.40	490NTC00005	—
		15/ 49.21	490NTC00015	—
		ConneXium cordsets (conforming to UL and CSA 22.1 standards)		
Straight shielded twisted pair cordsets	2 RJ45 connectors	2/ 6.56	490NTW00002U	—
		5/ 16.40	490NTW00005U	—
		15/ 49.21	490NTW00012U	—
Crossed shielded twisted pair cordsets	2 RJ45 connectors	5/ 16.40	490NTC00005U	—

(1) Also available in 40 and 80 m/131 and 262 ft lengths.

To order other ConneXium connection components, please refer to our website www.schneider-electric.com.

EtherCAT fieldbus

Presentation

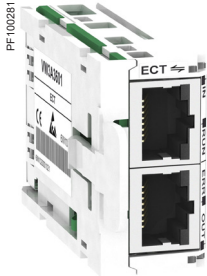

VW3A3601 EtherCAT communication card

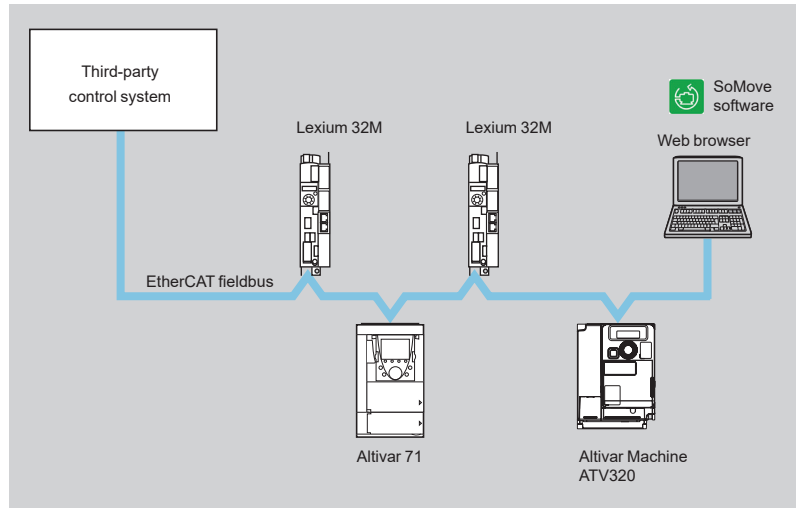

EtherCAT (EtherNet for Control Automation Technology) is an EtherNet-based open fieldbus system. This means that EtherNet technologies, such as embedded Web server, e-mail, and FTP transfer, can be used in the EtherCAT environment. The EtherCAT fieldbus is intended for applications requiring very short cycle times ($\leq 250 \mu\text{s}$) with low jitter ($\leq 1 \mu\text{s}$) for synchronization purposes. These characteristics enable the EtherCAT network to achieve very high performance levels in the control systems field, with low equipment costs.

Reference

Description	For use with	Type of port	Reference	Weight kg/lb
EtherCAT card	Lexium 32M servo drives	2 RJ45 connectors	VW3A3601	0.300/ 0.661

EtherCAT fieldbus connection accessories

Description	Type of port	Length m/ft (1)	Reference	Weight kg/lb
ConneXium cordsets (conforming to EIA/TIA-568, category 5, and IEC1180/EN50173, class D, standards)				
Straight shielded twisted pair cordsets	2 RJ45 connectors	2/	490NTW00002	–
		6.56	490NTW00005	–
		5/	490NTW00012	–
		16.40		
		12/	490NTW00012	–
		39.37		
Crossed shielded twisted pair cordsets	2 RJ45 connectors	5/	490NTC00005	–
		16.40	490NTC00015	–
		15/		–
		49.21		
ConneXium cordsets (conforming to UL and CSA 22.1 standards)				
Straight shielded twisted pair cordsets	2 RJ45 connectors	2/	490NTW00002U	–
		6.56	490NTW00005U	–
		5/	490NTW00012U	–
		16.40		
		15/	490NTW00012U	–
		49.21		
Crossed shielded twisted pair cordsets	2 RJ45 connectors	5/	490NTC00005U	–
		16.40		–

(1) Also available in 40 and 80 m/131 and 262 ft lengths.

To order other ConneXium connection components, please refer to our website www.schneider-electric.com.

PROFINET fieldbus

Presentation



VW3M3308 PROFINET communication card

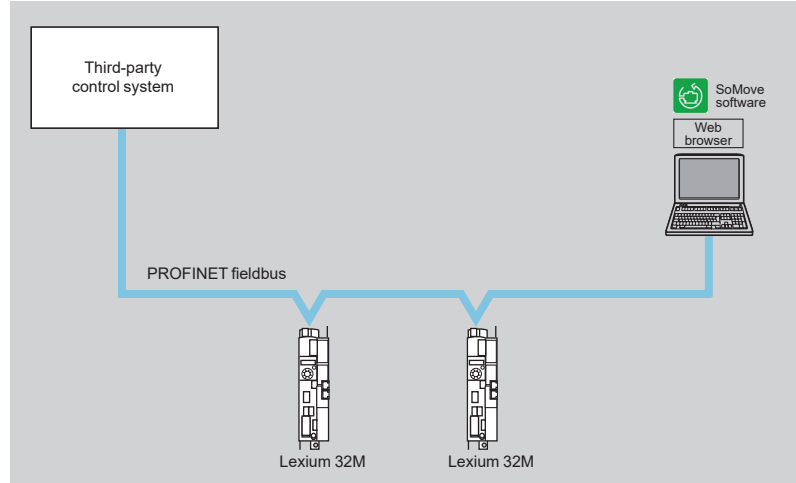

PROFINET is an Ethernet-based fieldbus that allows you to network products from different manufacturers without the need for special interface adaptation.

The following functions can be performed via the fieldbus:

- Reading and writing parameters
- Reading and writing inputs and outputs
- Diagnostics and monitoring functions

Networking the product:

- The product is networked via an RJ45 interface and operates as an I/O device on the PROFINET network. Data is exchanged according to the producer-consumer model.

Reference				
Description	For use with	Type of port	Reference	Weight kg/lb
PROFINET card	Lexium 32M servo drives	2 RJ45 connectors	VW3M3308	0.300/ 0.661
PROFINET fieldbus connection accessories				
Description	Type of port	Length m/ft (1)	Reference	Weight kg/lb
ConneXium cordsets (conforming to EIA/TIA-568, category 5 and IEC1180/EN50173, class D standards)				
Straight shielded twisted pair cordsets	2 RJ45 connectors	2/ 6.56	490NTW00002	—
		5/ 16.40	490NTW00005	—
		12/ 39.37	490NTW00012	—
Crossed shielded twisted pair cordsets	2 RJ45 connectors	5/ 16.40	490NTC00005	—
		15/ 49.21	490NTC00015	—
ConneXium cordsets (conforming to UL and CSA 22.1 standards)				
Straight shielded twisted pair cordsets	2 RJ45 connectors	2/ 6.56	490NTW00002U	—
		5/ 16.40	490NTW00005U	—
		15/ 49.21	490NTW00012U	—
Crossed shielded twisted pair cordsets	2 RJ45 connectors	5/ 16.40	490NTC00005U	—

(1) Also available in 40 and 80 m/131 and 262 ft lengths.

To order other ConneXium connection components, please refer to our website www.schneider-electric.com.

Modbus TCP network

Presentation

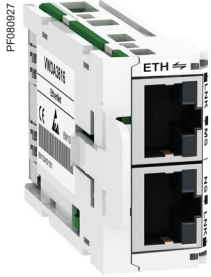

VW3A3616 Modbus TCP communication card

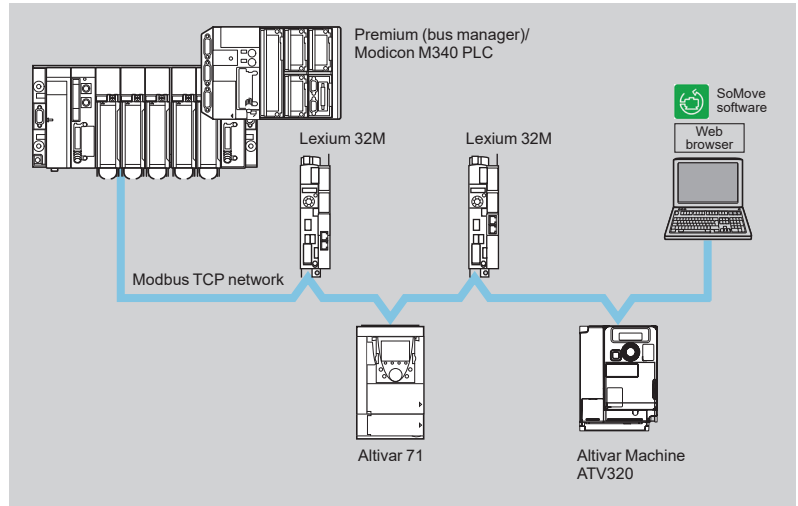

Different products with a Modbus TCP interface can be operated in the same fieldbus.

Modbus TCP provides a common basis for interchanging commands and data between the network devices.

The product supports the following functions via Modbus TCP:

- Automatic IP address assignment via BOOTP or DHCP
- Automatically obtaining configuration data via the FDR (Fast Device Replacement) service
- Commissioning via commissioning software
- Diagnostics and configuration via integrated Web server
- Reading and writing parameters
- Controlling the drive
- Monitoring inputs and outputs
- Diagnostics and monitoring functions

Reference

Description	For use with	Type of port	Reference	Weight kg/lb
Modbus TCP card ■ 10/100 Mbps, half and full duplex ■ Embedded Web server	Lexium 32M servo drives	2 RJ45 connectors	VW3A3616	0.300/ 0.661

Modbus TCP network connection accessories

Description	Type of port	Length m/ft (1)	Reference	Weight kg/lb
ConneXium cordsets (conforming to EIA/TIA-568, category 5 and IEC1180/EN50173, class D standards)				
Straight shielded twisted pair cordsets	2 RJ45 connectors	2/ 6.56	490NTW00002	–
		5/ 16.40	490NTW00005	–
		12/ 39.37	490NTW00012	–
Crossed shielded twisted pair cordsets	2 RJ45 connectors	5/ 16.40	490NTC00005	–
		15/ 49.21	490NTC00015	–
		ConneXium cordsets (conforming to UL and CSA 22.1 standards)		
Straight shielded twisted pair cordsets	2 RJ45 connectors	2/ 6.56	490NTW00002U	–
		5/ 16.40	490NTW00005U	–
		15/ 49.21	490NTW00012U	–
Crossed shielded twisted pair cordsets	2 RJ45 connectors	5/ 16.40	490NTC00005U	–

(1) Also available in 40 and 80 m/131 and 262 ft lengths.

To order other ConneXium connection components, please refer to our website www.schneider-electric.com.

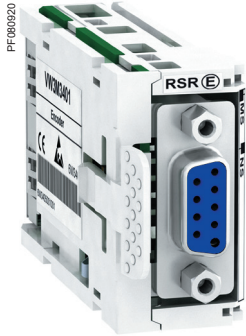

VW3M3401 resolver card

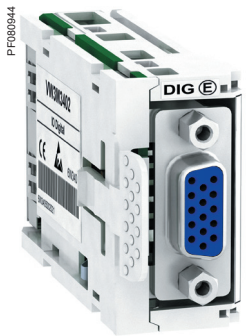

VW3M3402 encoder interface card (digital output)

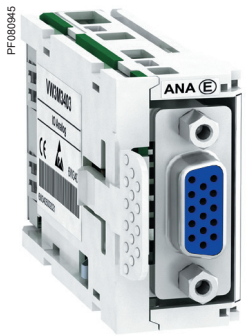

VW3M3403 encoder interface card (analog output)

Presentation

The Lexium 32M servo drive can take an encoder interface card. This has an input available for an additional encoder, thus offering the following advantages:

- The ability to connect to third-party motors, which increases the installation's flexibility
- The ability to improve positioning accuracy by reducing the effect of mechanical backlash thanks to position measurement directly on the machine, and to meet the requirements of simple applications or complex systems that need a very quick response or very accurate path following

3 cards are available depending on the encoder technology:

- Resolver encoder
- Encoder with digital output
- Encoder with analog output

References

Description	Technology type	Power supply	Encoder type		Reference	Weight
			Machine encoder	Motor encoder		
						kg/lb
Resolver card					VW3M3401	–
Encoder interface card with digital output	A/B/I	5			VW3M3402	–
	SSI	12				
	BISS	5				
	EnDat 2.2	5				
Encoder interface card with analog output	1 Vpp	5			VW3M3403	–
	1 Vpp/Hall	5				
	Hiperface	12				

Connection accessories

Description	Composition	Length m/ft	Reference	Weight kg/lb
Cordset				
Cordset equipped with 1 x 15-way high density male SUB-D connector For card with digital or analog output	–	1/ 3.28	VW3M4701	–
Connecting cable				
Cable for creating cordsets for encoder interface cards	[5 x (2 x 0.25 mm ² / AWG 24) + (2 x 0.5 mm ² / AWG 20)]	100/ 328.08	VW3M8221R1000	21.000/ 46.297

Lexium 32 and Motors

Lexium 32 Servo drives

Option: Encoder cards for Lexium 32M servo drives



incremental encoder



Absolute encoder

Machine encoders for VW3M3402 encoder card

Presentation

To meet requirements for machine encoders, Schneider Electric recommends the XCC range of Opto-electronic rotary encoders, made by Telemecanique Sensors. The rotary encoders are connected to the VW3M3402 encoder interface card with digital output

The XCC offer consists of incremental encoders and absolute encoders:

- The incremental encoder, with configurable resolution and A/B/I output signal
- The absolute encoders with SSI interface.

More information on XCC offer, Please consult www.tesensors.com web-site.

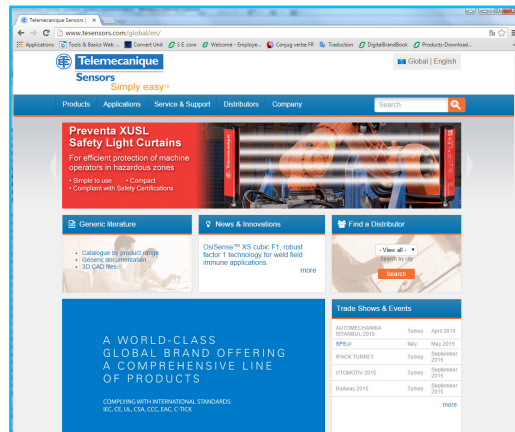

- > Discover XMLP offer on the web site: <http://www.tesensors.com/global>
- > Access to the catalog by product at this URL: <http://www.tesensors.com/global/en/product/catalog/>

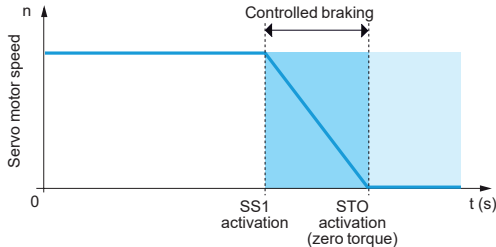

Activation of the Safe Stop 1 (SS1) function

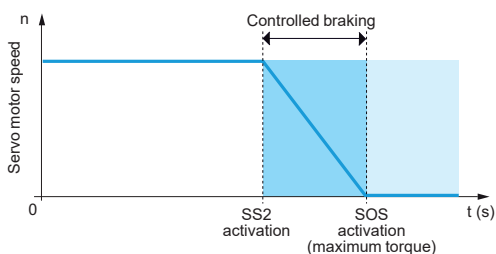

Activation of the Safe Stop 2 (SS2) function

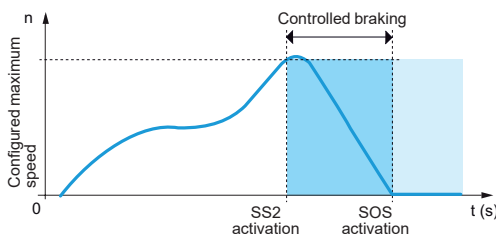

Activation of the Safe Limited Speed (SLS) function

PF080921

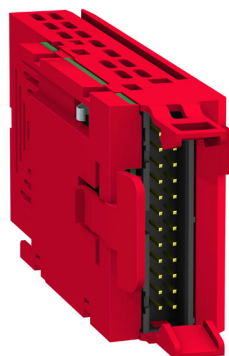

VW3M3501 safety card

Presentation

The eSM safety card allows Lexium 32 servo drives to access additional safety functions as well as the Safety Torque Off (STO) function. This offers a complex safety device that helps to provide installation monitoring.

The eSM card optimizes the overall cost of the installation by avoiding the need for additional external devices, while conforming to international safety standards. As a result, wiring is cheaper and quicker.

It also improves performance during maintenance by reducing machine or installation downtime and increases the safety of any work carried out.

The eSM card complies with the machinery standard ISO 13849-1, performance level "e" (PL e), functional safety standard IEC/EN 61508, SIL 3 capability, and functional safety standard IEC/EN 62061, SIL 3 capability.

It includes safety functions compliant with standard IEC/EN 61800-5-2. These functions, required in the majority of applications, are as follows:

- Safe Torque Off (STO)
- Safe Stop 1 (SS1)
- Safe Stop 2 (SS2)
- Safe Limited Speed (SLS)
- Safe Operating Stop (SOS)

Safety functions

Safe Stop 1 (SS1) function

The SS1 function is used to achieve a category 1 safe stop. After activation of the function, the servo motor is braked in a controlled manner, maintaining the power on the actuators. The power is then removed when the actuators stop after the machine has come to a halt.

Safe Stop 2 (SS2) function

The SS2 function is used to achieve a category 2 safe stop. After activation of the function, the servo motor is braked in a controlled manner, maintaining the power on the actuators. Once the motor has come to a halt, it is kept at a standstill with the Safe Operating Stop (SOS) function.

Safe Limited Speed (SLS) function

The SLS function is used to monitor the configured maximum speed. If this speed is exceeded, the servo motor will be stopped in accordance with SS2.

Safe Operating Stop (SOS) function

The SOS function is used to monitor any deviation from the standstill position once the servo motor has come to a halt.

References

Description	Power supply	Cable length	Unit reference	Weight
	V	m/ft		kg/lb
eSM safety card for Lexium 32M servo drives	24 V (min. 19, max. 30)	–	VW3M3501	–
Cordset preassembled with a 24-way female connector (safety card end) and a free end	–	3/9.84	VW3M8801R30	–
Cordsets preassembled with 2 x 24-way female connectors	–	1.5/4.92	VW3M8802R15	–
		3/9.84	VW3M8802R30	–
eSM distribution unit equipped with 5 connectors	–	–	VW3M8810	–
Removable connector for connecting an additional eSM distribution unit	–	–	VW3M8820	–

Sold in lots of 4

Lexium 32 and Motors

Lexium 32 Servo drives

Option: I/O expansion card for Lexium 32M servo drives

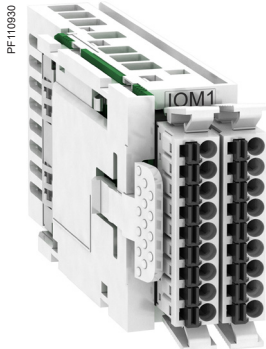

VW3M3302 I/O expansion card

Presentation

Lexium 32M (1) servo drives can be adapted for more complex or more extensive applications by installing an I/O expansion card.

It has the same functions as the Lexium 32M servo drive I/O.

The I/O expansion card is inserted into a dedicated slot (port no. 1). It is compatible with servo drives supporting version V01.06 minimum.

The card has logic and analog I/O:

- 4 x 24 V $\overline{\text{V}}$ positive logic (Source) or negative logic (Sink) inputs
- 2 positive logic (Source) or negative logic (Sink) open collector outputs
- 2 software-configurable voltage (0...10 V $\overline{\text{V}}$) analog inputs, 14-bit resolution
- 2 software-configurable voltage (0...10 V $\overline{\text{V}}$) or current (0...20 mA) analog outputs, 12-bit resolution

Reference

Description	Type of I/O		Type of connection	Reference	Weight kg/lb
	Logic I/O	Analog I/O			
I/O expansion card for Lexium 32M (1) servo drives	4 inputs	2 outputs	2 inputs 2 outputs	Spring terminals	VW3M3302 0.400/ 0.882

(1) Except with LXM32M servo drives with Sercos.

Presentation

Internal braking resistor

A braking resistor is built into the servo drive to absorb the braking energy. If the DC bus voltage in the servo drive exceeds a specified value, this braking resistor is activated. The restored energy is converted into heat by the braking resistor.

It enables maximum transient braking torque.

External braking resistor

- When the servo motor has to be braked frequently, an external braking resistor is required to dissipate the excess braking energy. In this case, the internal braking resistor must be deactivated.
- Several external braking resistors can be connected in parallel. The servo drive monitors the power dissipated in the braking resistor.
- The degree of protection of the casing is IP 65 for VW3A7601R●● to VW3A7608R●● braking resistors, and IP 20 for VW3A773●● braking resistors. The operating temperature around the unit can be between 0 and + 50 °C/+ 32 and + 122 °F.
- To optimize the size of the braking resistor, the DC buses on Lexium 32 servo drives in the same installation can be connected in parallel

Applications

Machines with high inertia, driving loads, and machines with fast cycles.

References

Ohmic value	Continuous power PPr	Peak energy EPk				Length of connection cable	Reference	Weight	
		115 V	230 V	400 V	480 V				
Ω	W	Ws	Ws	Ws	Ws	m/ft		kg/lb	
10	400	18,800	13,300	7,300	7,300	0.75/2.46	VW3A7601R07	1.420/ 3.131	
						2/6.56	VW3A7601R20	1.470/ 3.241	
						3/9.84	VW3A7601R30	1.620/ 3.571	
	1100	-	-	-	-	-	-	VW3A7734	5.500/ 12.125
							-	VW3A7733	4.000/ 8.818
							-	VW3A7733	4.000/ 8.818
	16	100	4,200	3,800	1,900	1,900	0.75/2.46	VW3A7602R07	0.630/ 1.389
							2/6.56	VW3A7602R20	0.780/ 1.720
							3/9.84	VW3A7602R30	0.930/ 2.050
200		9,700	7,400	4,900	4,300	4,300	0.75/2.46	VW3A7603R07	0.930/ 2.050
							2/6.56	VW3A7603R20	1.080/ 2.381
							3/9.84	VW3A7603R30	1.200/ 2.646
400		25,500	18,100	11,400	10,500	10,500	0.75/2.46	VW3A7604R07	1.420/ 3.131
							2/6.56	VW3A7604R20	1.470/ 3.241
							3/9.84	VW3A7604R30	1.620/ 3.571
72		100	5,500	3,700	2,500	2,300	0.75/2.46	VW3A7605R07	0.620/ 3.571
							2/6.56	VW3A7605R20	0.750/ 1.653
							3/9.84	VW3A7605R30	0.850/ 1.874
	200	14,600	9,600	6,600	6,000	6,000	0.75/2.46	VW3A7606R07	0.930/ 2.050
							2/6.56	VW3A7606R20	1.080/ 2.381
							3/9.84	VW3A7606R30	1.200/ 2.646
	400	36,600	24,700	16,200	15,500	15,500	0.75/2.46	VW3A7607R07	1.420/ 3.131
							2/6.56	VW3A7607R20	1.470/ 3.241
							3/9.84	VW3A7607R30	1.620/ 3.571
100	100	4,400	4,400	2,900	2,900	0.75/2.46	VW3A7608R07	0.410/ 0.904	
						2/6.56	VW3A7608R20	0.560/ 1.235	
						3/9.84	VW3A7608R30	0.760/ 1.676	

Note: The total continuous power dissipated in the external braking resistor(s) must be less than or equal to the nominal power of the Lexium 32 servo drive (see pages 8 and 9).



Presentation

A line choke can be used to provide improved protection against overvoltages on the line supply and to reduce harmonic distortion of the current produced by the servo drive.

The recommended chokes limit the line current. They have been developed in line with standard IEC 61800-5-1 (VDE 0160 level 1 high-energy overvoltages on the line supply).

The inductance values are defined for a voltage drop between 3% and 5% of the nominal line voltage. Values higher than this will cause loss of torque.

These chokes must be installed upstream of the servo drive. One line choke can be connected to a number of servo drives. In such cases, the current consumption of all the servo drives at nominal voltage must not exceed the nominal current of the line choke.

The use of line chokes is recommended in particular under the following circumstances:

- Close connection of several servo drives in parallel
- Line supply with significant disturbance from other equipment (interference, overvoltages)
- Line supply with voltage unbalance between phases that is more than 1.8% of the nominal voltage
- Servo drive supplied by a line with very low impedance (in the vicinity of a power transformer 10 times more powerful than the servo drive rating)
- Installation of a large number of servo drives on the same line
- Reduction of overloads on the $\cos \varphi$ correction capacitors, if the installation includes a power factor correction unit.

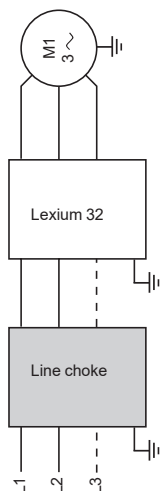

References

For servo drive	Inductance value mH	Losses W	Line current and THD				Reference	Weight kg/lb
			Without choke		With choke			
			A	%	A	%		
Single-phase supply voltage: 115 V ~ 50/60 Hz								
LXM32●U45M2	5	20	2.9	173	2.6	85	VZ1L007UM50	0.880/ 1.940
LXM32●U90M2	2	30	5.4	159	5.2	90	VZ1L018UM20	1.990/ 4.387
LXM32●D18M2	2	30	8.5	147	9.9	74		
LXM32●D30M2	2	30	12.9	135	9.9	72		
Single-phase supply voltage: 230 V ~ 50/60 Hz								
LXM32●U45M2	5	20	2.9	181	3.4	100	VZ1L007UM50	0.880/ 1.940
LXM32●U90M2	2	30	4.5	166	6.3	107	VZ1L018UM20	1.990/ 4.387
LXM32●D18M2	2	30	8.4	148	10.6	93		
LXM32●D30M2	2	30	12.7	135	14.1	86		
Three-phase supply voltage: 380 V ~ 50/60 Hz								
LXM32●U60N4	2	75	1.4	187	1.9	106	VW3A4553	3.500/ 7.716
LXM32●D12N4	2	75	3	174	3.5	88		
LXM32●D18N4	1	90	5.5	159	7.2	88	VW3A4554	6.000/ 13.228
LXM32●D30N4	1	90	8.7	146	11.6	74		
LXM32●D72N4	1	90	18.1	124	23.5	43		
LXM32MD85N4	1	90	23.3	139	25	45		
LXM32MC10N4	0.5	94	27.8	133	38.1	70	VW3A4555	11.000/ 24.251
Three-phase supply voltage: 480 V ~ 50/60 Hz								
LXM32●U60N4	2	75	1.2	201	1.6	116	VW3A4553	3.500/ 7.716
LXM32●D12N4	2	75	2.4	182	2.9	98		
LXM32●D18N4	1	90	4.5	165	6	98	VW3A4554	6.000/ 13.228
LXM32●D30N4	1	90	7	152	9.6	85		
LXM32●D72N4	1	90	14.6	129	19.5	55		
LXM32MD85N4	1	90	19.9	145	21	45		
LXM32MC10N4	0.5	94	23.7	140	32	54	VW3A4555	11.000/ 24.251

Lexium 32 and Motors

Lexium 32 Servo drives

Integrated EMC filters

Additional EMC input filters

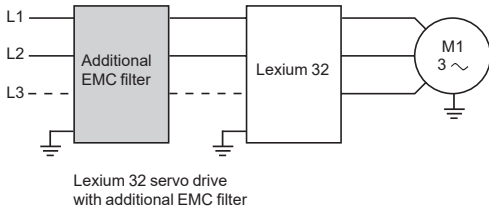
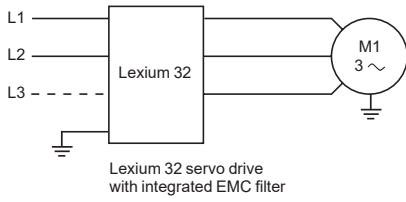

Additional EMC filter mounted on a Lexium 32M servo drive

Integrated EMC filter

Function

Lexium 32 servo drives have integrated radio interference input filters to comply with the EMC standard for variable speed electrical power drive “products” IEC/EN 61800-3, edition 2, category C3 in environment 2, and to comply with the European directive on EMC (electromagnetic compatibility).

For servo drive

Maximum servo motor cable length conforming to

EN 55011, class A, Gr2

IEC/EN 61800-3, category C3 in environment 2 (1)

Switching frequency: 8 kHz

m/ft

Single-phase supply voltage: 115 V ~ 50/60 Hz

LXM32●●●●M2 20/65.62 (10 m/32.81 ft in category C2, environment 1)

Single-phase supply voltage: 230 V ~ 50/60 Hz

LXM32●●●●M2 20/65.62 (10 m/32.81 ft in category C2, environment 1)

Three-phase supply voltage: 380 V ~ 50/60 Hz

LXM32●●●●N4 20/65.62

Three-phase supply voltage: 480 V ~ 50/60 Hz

LXM32●●●●N4 20/65.62

Additional EMC input filters

Applications

Used with Lexium 32 servo drives, additional EMC input filters can be used to meet more stringent requirements and are designed to reduce conducted emissions on the line supply below the limits of standard IEC/EN 61800-3 edition 2, category C2 or C3 (see page 29).

Additional EMC filters are mounted on the side of the device. They have tapped holes for mounting in an enclosure.

Use according to the type of line supply

Integrated or additional EMC filters can only be used on TN (neutral connection) or TT (neutral to ground) systems.

Lexium 32 servo drives cannot be used on IT (impedance grounded or isolated neutral) systems. Standard IEC/EN 61800-3, appendix D2.1, states that on IT systems, filters can cause permanent insulation monitors to operate in a random manner.

If a machine has to be installed on an IT system, an isolation transformer must be inserted in order to re-create a TT system on the secondary side.

(1) Standard IEC/EN 61800-3: EMC immunity and conducted and radiated EMC emissions: - Category C3 in environment 2: industrial premises.

Lexium 32 and Motors

Lexium 32 Servo drives

Additional EMC input filters

PF065115



VW3A4422

PF065117



VW3A4424

References

For servo drive	Maximum servo motor shielded cable length conforming to			Reference	Weight
	EN 55011 class A Gr1	EN 55011 class A Gr2			
	IEC/EN 61800-3 category C2 (1) in environment 1	IEC/EN 61800-3 category C3 (1) in environment 2			
	Switching frequency	Switching frequency			
	8 kHz	4 kHz	8 kHz		
	m/ft	m/ft	m/ft		kg/lb
Single-phase supply voltage					
LXM32●U45M2	50/	–	100/	VW3A4420	0.600/
LXM32●U90M2	164		330		1.323
LXM32●D18M2	50/	–	100/	VW3A4421	0.775/
LXM32●D30M2	164		330		1.709
Three-phase supply voltage					
LXM32●U60N4	50/	–	100/	VW3A4422	0.900/
LXM32●D12N4	164		330		1.984
LXM32●D18N4					
LXM32●D30N4					
LXM32●D72N4	50/	–	100/	VW3A4423	1.350/
	164		330		2.976
LXM32MD85N4,	50/	100/	–	VW3A4424	3.150/
LXM32MC10N4	164	330			6.945

(1) Standard IEC/EN 61800-3: EMC immunity and conducted and radiated EMC emissions:
 - Category C2 in environment 1: restricted distribution, for domestic use, sale conditional on the competence of the user and the distributor in terms of reduction of current harmonics
 - Category C3 in environment 2: industrial premises.

Lexium 32 and Motors

Lexium 32 Servo drives

Motor starters

Applications

The combinations listed below can be used to create a complete motor starter unit comprising a contactor and a Lexium 32 servo drive.

The contactor turns on and manages any safety functions, as well as isolating the servo motor on stopping.

The servo drive controls the servo motor, provides protection against short-circuits between the servo drive and the servo motor, and helps to protect the motor cable against overloads. The overload protection is provided by the motor thermal protection of the servo drive.

Motor starters for Lexium 32 servo drives

Servo drive		Max. prospective line Isc	Contactor
Reference	Nominal power		Reference (1) (2)
	kW	kA	
Single-phase supply voltage: ~ 100...120 V 50/60 Hz			
LXM32●U45M2	0.15	1	LC1D09●●
LXM32●U90M2	0.3	1	LC1D09●●
LXM32●D18M2	0.5	1	LC1D12●●
LXM32●D30M2	0.8	1	LC1D18●●
Single-phase supply voltage: ~ 200...240 V 50/60 Hz			
LXM32●U45M2	0.3	1	LC1D09●●
LXM32●U90M2	0.5	1	LC1D09●●
LXM32●D18M2	1	1	LC1D12●●
LXM32●D30M2	1.6	1	LC1D18●●
Three-phase supply voltage: ~ 400 V 50/60 Hz			
LXM32●U60N4	0.4	5	LC1D09●●
LXM32●D12N4	0.9	5	LC1D09●●
LXM32●D18N4	1.8	5	LC1D09●●
LXM32●D30N4	3	5	LC1D12●●
LXM32●D72N4	7	5	LC1D25●●
LXM32MD85N4	9	22	LC1D25●●
LXM32MC10N4	11	22	LC1D25●●
Three-phase supply voltage: ~ 480 V 50/60 Hz			
LXM32●U60N4	0.4	5	LC1D09●●
LXM32●D12N4	0.9	5	LC1D09●●
LXM32●D18N4	1.8	5	LC1D09●●
LXM32●D30N4	3	5	LC1D12●●
LXM32●D72N4	7	5	LC1D25●●
LXM32MD85N4	9	22	LC1D25●●
LXM32MC10N4	11	22	LC1D25●●

(1) Composition of contactors :

LC1D●●: 3 poles + 1 NO auxiliary contact and 1 NC auxiliary contact.

In certain solutions, it is possible to use an LC1K contactor with 1 NC auxiliary contact.

Please refer to the "Control and protection components" catalog.

(2) Replace ●● with the control circuit voltage reference given in the table below:

	Volts ~	24	48	110	220/230	230	230/240
LC1D●●	50 Hz	B5	E5	F5	M5	P5	U5
	50 Hz	B6	E6	F6	M6	-	U6
	50/60 Hz	B7	E7	F7	M7	P7	U7

For other available voltages between 24 and 660 V, or for a DC control circuit, please consult our website www.schneider-electric.com.



LC1D18●●
+
LXM32MD30M2

LC1D25●●
+
LXM32MD85N4

Lexium 32 and Motors

Lexium 32 Servo drives

Protection using fuses

Protection using class J fuses (UL certification)			
Servo drive		Fuse to be placed upstream	
Reference	Nominal power kW	min. A	max. A
Single-phase supply voltage: ~ 100...120 V 50/60 Hz			
LXM32●U45M2	0.15	4	25
LXM32●U90M2	0.3	6	25
LXM32●D18M2	0.5	10	25
LXM32●D30M2	0.8	15	25
Single-phase supply voltage: ~ 200...240 V 50/60 Hz			
LXM32●U45M2	0.3	4	25
LXM32●U90M2	0.5	6	25
LXM32●D18M2	1	10	25
LXM32●D30M2	1.6	15	25
Three-phase supply voltage: ~ 400 V 50/60 Hz			
LXM32●U60N4	0.4	2	30/32 (1)
LXM32●D12N4	0.9	4	30/32 (1)
LXM32●D18N4	1.8	8	30/32 (1)
LXM32●D30N4	3	10	30/32 (1)
LXM32●D72N4	7	20	30/32 (1)
LXM32MD85N4	9	30	60/63 (2)
LXM32MC10N4	11	40	60/63 (2)
Three-phase supply voltage: ~ 480 V 50/60 Hz			
LXM32●U60N4	0.4	2	30/32 (1)
LXM32●D12N4	0.9	3	30/32 (1)
LXM32●D18N4	1.8	8	30/32 (1)
LXM32●D30N4	3	10	30/32 (1)
LXM32●D72N4	7	20	30/32 (1)
LXM32MD85N4	9	30	60/63 (2)
LXM32MC10N4	11	40	60/63 (2)

(1) Europe: 30 A fuse; US: 32 A fuse.

(2) Europe: 60 A fuse; US: 63 A fuse.



BMH servo motor with straight connectors



BMH servo motor with rotatable elbow connectors

Presentation

BMH servo motors provide excellent power density values to meet the requirements of compact machines. With four flange sizes and three different lengths for each flange size, they are suitable for many applications, covering a continuous stall range from 1.2 to 84 Nm for speeds up to 8,000 rpm.

The new BMH servo motors have a medium inertia motor, which means they are particularly suitable for high-load applications. They help to simplify installation and adjustment through a more robust adjustment of the movement.

BMH servo motors are UL Recognized  and conform to standard UL1004 as well as to European directives (CE marking).

They are available with the following variants:

- 5 flange sizes: 70, 100, 140 and 190 mm/2.76, 3.94, 5.51 and 7.48 in.
- 2 degrees of protection for the shaft end: IP 50 or IP 65 (IP 67 with the conformity kit, which is available as an option) in accordance with standard IEC/EN 60529. The degree of protection of the casing is IP 65 (IP 67 with the conformity kit, which is available as an option).
- With or without holding brake
- Straight or elbow connectors for power and encoder connection
- Integrated single-turn or multi-turn SinCos Hiperface® encoder (medium or high resolution)
- Smooth or keyed shaft end

Special features

BMH servo motors have been developed to comply with the following main specifications:

- The ambient operating temperature is - 20...+ 40 °C / - 4...+ 104 °F without derating, in accordance with standard IEC 60721-3-3, category 3K3, and up to 55 °C/131 °F with derating of 1% of the nominal output power per additional °C above 40 °C/104 °F.
- The maximum operating altitude is 1,000 m/3,280 ft without derating, 2,000 m/6,561 ft with $k = 0.86$, and 3,000 m/9,842 ft with $k = 0.8$ (1).
The relative humidity that the servo motor can withstand is in line with standard IEC 60721-3-3, categories 3K3, 3Z12, and 3Z2.
- The windings are insulation class F (maximum temperature for windings 155 °C/311 °F) in accordance with standard IEC 60034-1.
- Thermal protection is provided and controlled by the Lexium 32 servo drive via the motor temperature control algorithm.
- All mounting positions are permitted (horizontal mounting (IMB5) or vertical mounting (IMV1 with shaft end at the top and IMV3 with shaft end at the bottom) in accordance with standard IEC 60034-7.

Sizing

The Lexium Sizer tool is available on our website www.schneider-electric.com to help you size your servo motor.

(1) *k*: derating factor

Presentation (continued)

Holding brake

BMH servo motors can be equipped with an electromagnetic holding brake.

⚠ Do not use the holding brake as a dynamic brake for deceleration, as this will quickly damage the brake.

Integrated encoder

BMH servo motors are equipped as standard with an absolute encoder.

This encoder performs the following functions:

- Gives the absolute position of the motor so that flows can be synchronized
- Measures the servo motor speed via the associated Lexium 32 servo drive (this information is used by the servo drive's speed controller)
- Measures the position information for the servo drive's position controller
- Sends data from the servo motor to the servo drive, which provides automatic identification of the motor when the servo drive starts

Four types of encoder are available:

- High resolution SinCos Hiperface® encoder:
 - Single-turn (131,072 points/turn) (1)
 - Multi-turn (131,072 points/turn x 4,096 turns) (1)
 - Medium resolution SinCos Hiperface® encoder:
 - Single-turn (32,768 points/turn) (1)
 - Multi-turn (32,768 points/turn x 4,096 turns) (1)
- These encoders give an angular shaft position precise to less than ± 1.3 arc minutes.
These encoders give an angular shaft position precise to less than ± 4.8 arc minutes.

Description

BMH servo motors, with a 3-phase stator and a 10-pole rotor with Neodymium Iron Boron (NdFeB) magnets, consist of:

- 1 Casing with RAL 9005 opaque black paint protective coating
- 2 A 4-point axial mounting flange
- 3 A smooth or keyed shaft end (depending on the model)
- 4 A threaded sealed male straight connector for the power cable (2)
- 5 A threaded sealed male straight connector for the control cable (encoder) (2)

Cables and connectors to be ordered separately, for connection to Lexium 32 servo drives (see page 36).

Schneider Electric has taken particular care over the compatibility of BMH servo motors and Lexium 32 servo drives.

This compatibility is only possible when using cables and connectors sold by Schneider Electric (see page 36).

(1) Encoder resolution given for use with a Lexium 32 servo drive.

(2) For other model with rotatable elbow connector, see page 34.

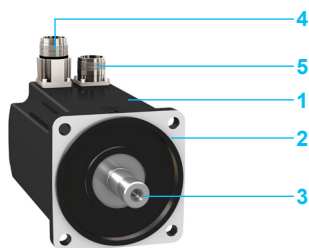

Lexium 32 and Motors

BMH servo motors



Front of the BMH070●●●●●1A



Front of the BMH100●●●●●1A

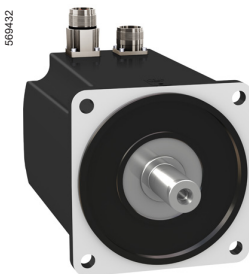

Front of the BMH1401P●●●●●1A

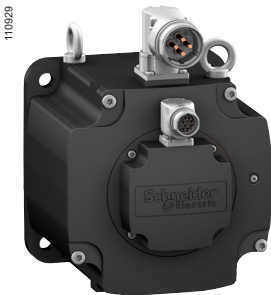

Rear view of the BMH1901P●●●●●2A

BMH servo motors

The BMH servo motors shown below are supplied without a gearbox.

For gearboxes, please consult "GBX and GBY planetary gearboxes" catalog or on our web site www.schneider-electric.com

Continuous stall torque	Peak stall torque	Nominal servo motor output power	Nominal speed	Maximum mechanical speed	Associated LXM32 servo drive	Reference (1)	Weight (2)
Nm	Nm	W	rpm	rpm			kg/lb
1.2	4.2	350	3,000	8,000	●U60N4	BMH0701P●●●●●A	1.600/ 3.527
1.4	4	450	4,000	8,000	●U90M2	BMH0701T●●●●●A	1.600/ 3.527
		350	2,500	8,000	●D18M2	BMH0701T●●●●●A	1.600/ 3.527
	700	5,000	8,000	●D12N4	BMH0701P●●●●●A	1.600/ 3.527	
2.5	6.4	600	2,500	8,000	●D30M2	BMH0702T●●●●●A	1.800/ 3.968
		900	4,000	8,000	●D18M2		
	700	3,000	8,000	●D12N4	BMH0702P●●●●●A	1.800/ 3.968	
3.4	8.7	650	2,000	8,000	●D30M2	BMH0703T●●●●●A	2.000/ 4.409
		900	3,000	8,000	●D18M2	BMH0703T●●●●●A	2.000/ 4.409
	1,300	5,000	8,000	●D18N4	BMH0703P●●●●●A	2.000/ 4.409	
3.3	10.8	800	4,000	6,000	●D12N4	BMH1001P●●●●●A	3.340/ 7.363
3.4	8.9	700	2,000	6,000	●D30M2	BMH1001T●●●●●A	3.340/ 7.363
		900	3,000	6,000	●D18M2		
	1,300	4,000	6,000	●D18N4	BMH1001P●●●●●A	3.340/ 7.363	
6	10.3	750	2,000	6,000	●D30M2	BMH1002T●●●●●A	4.920/ 10.847
		1,450	3,000	6,000	●D30M2		
5.9	18.4	1,600	4,000	6,000	●D18N4	BMH1002P●●●●●A	4.920/ 10.847
8	23.5	1,450	2,500	5,000	●D30M2	BMH1003T●●●●●A	6.500/ 14.330
8.4	25.1	2,600	4,000	5,000	●D30N4	BMH1003P●●●●●A	6.500/ 14.330
10.3	30.8	1,450	1,500	4,000	●D30M2	BMH1401P●●●●●A	8.000/ 17.637
		2,400	3,000	4,000	●D30N4		
16.8	50.3	3,800	3,000	4,000	●D72N4	BMH1402P●●●●●A	12.000/ 26.455
24	71.8	4,500	3,000	4,000	●D72N4	BMH1403P●●●●●A	16.000/ 35.274
		4,800	2,500	4,000	●D72N4	BMH1901P●●●●●A	19.000/ 41.888
		5,180	3,000	4,000	MD85N4		
37.4	101	5,180	3,000	4,000	MC10N4		
		5,900	2,500	4,000	●D72N4	BMH1902P●●●●●A	31.000/ 68.343
		6,070	2,000	4,000	MD85N4		
48	130.7	6,070	2,000	4,000	MC10N4		
		5,700	1,500	3,500	●D72N4	BMH1903P●●●●●A	43.000/ 94.799
57.6	141.3	7,330	2,000	3,500	MD85N4		
65	162.7	7,750	2,000	3,500	MC10N4		
100	230	9800	2000	3000	MC10N4	BMH1904P●●●●●A	67.000/ 147.71

(1) To complete each reference see the table on page 35.

(2) Weight of servo motor without brake, no packaging. To obtain the weight of the servo motor with holding brake, please visit our website www.schneider-electric.com.

BMH servo motors (continued)					
To order a BMH servo motor, complete each reference with:					
		BMH0701P	•	•	•
Shaft end	IP 54	Smooth (1)	0		
		Keyed (1)	1		
	IP 65/IP 67 (2)	Smooth	2		
		Keyed	3		
Integrated sensor High resolution, optical	Single-turn, SinCos Hiperface® 131,072 points/turn (3) 128 sine/cosine periods per turn		1		
	Multi-turn, SinCos Hiperface® 131,072 points/turn x 4,096 turns (3) 128 sine/cosine periods per turn		2		
Integrated sensor Medium resolution, capacitive	Single-turn, SinCos Hiperface® 32,768 points/turn (3) 16 sine/cosine periods per turn		6 (1)		
	Multi-turn, SinCos Hiperface® 32,768 points/turn x 4,096 turns (3) 16 sine/cosine periods per turn		7 (1)		
Holding brake	Without			A	
	With			F	
Connections	Straight connectors (1)				1
	Rotatable right angle elbow connectors				2
Flange	International standard				A
Motor with fan option	Available for BMH1904 only				B

Dimensions (overall)			
Servo motors	Flange	Width x Height x Depth (4)	
		Without holding brake	With holding brake
	mm/in.	mm/in.	mm/in.
BMH0701●	70 x 70/ 2.76 x 2.76	70 x 109.5 x 122/ 2.76 x 4.31 x 4.80	70 x 109.5 x 161/ 2.76 x 4.31 x 6.34
BMH0702●	70 x 70/ 2.76 x 2.76	70 x 109.5 x 154/ 2.76 x 4.31 x 6.06	70 x 109.5 x 193/ 2.76 x 4.31 x 7.60
BMH0703●	70 x 70/ 2.76 x 2.76	70 x 109.5 x 186/ 2.76 x 4.31 x 7.32	70 x 109.5 x 225/ 2.76 x 4.31 x 8.86
BMH1001●	100 x 100/ 3.94 x 3.94	100 x 139.5 x 128/ 3.94 x 5.49 x 5.04	100 x 139.5 x 170/ 3.94 x 5.49 x 6.69
BMH1002●	100 x 100/ 3.94 x 3.94	100 x 139.5 x 160/ 3.94 x 5.49 x 6.30	100 x 139.5 x 202/ 3.94 x 5.49 x 7.95
BMH1003●	100 x 100/ 3.94 x 3.94	100 x 139.5 x 192/ 3.94 x 5.49 x 7.60	100 x 139.5 x 234/ 3.94 x 5.49 x 9.21
BMH1401P	140 x 140/ 5.51 x 5.51	140 x 179.5 x 152/ 5.51 x 7.07 x 5.98	140 x 179.5 x 187/ 5.51 x 7.07 x 7.36
BMH1402P	140 x 140/ 5.51 x 5.51	140 x 179.5 x 192/ 5.51 x 7.07 x 7.60	140 x 179.5 x 227/ 5.51 x 7.07 x 8.94
BMH1403P	140 x 140/ 5.51 x 5.51	140 x 179.5 x 232/ 5.51 x 7.07 x 9.13	140 x 179.5 x 267/ 5.51 x 7.07 x 10.51
BMH1901P	190 x 190/ 7.48 x 7.48	190 x 257 x 190/ 7.48 x 10.12 x 7.48	190 x 257 x 248/ 7.48 x 10.12 x 9.76
BMH1902P	190 x 190/ 7.48 x 7.48	190 x 257 x 250/ 7.48 x 10.12 x 9.84	190 x 257 x 308/ 7.48 x 10.12 x 12.13
BMH1903P	190 x 190/ 7.48 x 7.48	190 x 257 x 310/ 7.48 x 10.12 x 12.21	190 x 257 x 368/ 7.48 x 10.12 x 14.49
BMH1904P	190 x 190/ 7.48 x 7.48	190 x 257 x 383/ 7.48 x 10.12 x 15.07	190 x 257 x 456/ 7.48 x 10.12 x 17.95

Note: The example above is for a **BMH0701P** servo motor. For other servo motors, replace **BMH0701P** with the relevant reference.

(1) Not available for BMH190 servo motors.

(2) IP 67 with the VW3M230● IP 67 conformity kit supplied as an option (see page 36).

(3) Sensor resolution given for use with a Lexium 32 servo drive.

(4) D: motor length (excluding shaft end).

(5) Height of the servo motor equipped with straight connectors. The height is 265 mm/10.43 in. when the servo motor is equipped with rotatable elbow connectors.

Lexium 32 and Motors

BMH servo motors
IP 67 conformity kits
Connection components

PF080922



VW3M230●

IP 67 conformity kits

This kit can be used to provide IP 67 degree of protection. It is mounted in place of the motor backplate.

Description	For use with	Reference	Weight kg/lb
IP 67 conformity kits (supplied as an option)	BMH070●●	VW3M2301	0.100/ 0.220
	BMH100●●	VW3M2302	0.150/ 0.331
	BMH140●●	VW3M2303	0.300/ 0.661
	BMH190●●	(1)	0.003/ 0.007

Connection components

Power cordsets							
Description	From servo motor	To servo drive	Composition	Length m/ft	Reference	Weight kg/lb	
Cordsets equipped with one M23 industrial connector (servo motor end)	BMH070●●	LXM32●●●●●●	[[4 x 1.5 mm ² / AWG 16) + (2 x 1 mm ² / AWG 17)]	1.5/ 3.28	VW3M5101R15	0.600/ 1.323	
	BMH100●●	See combinations on page 6		3/ 9.84	VW3M5101R30	0.810/ 1.786	
	BMH1401P			5/ 16.40	VW3M5101R50	1.210/ 2.668	
				10/ 32.81	VW3M5101R100	2.290/ 5.049	
				15/ 49.21	VW3M5101R150	3.400/ 7.496	
				20/ 65.62	VW3M5101R200	4.510/ 9.943	
				25/ 82.02	VW3M5101R250	6.200/ 13.669	
				50/ 164.04	VW3M5101R500	12.325/ 26.974	
				75/ 246.06	VW3M5101R750	18.450/ 40.675	
	BMH1402P	LXM32●D72N4		[[4 x 2.5 mm ² / AWG 14) + (2 x 1 mm ² / AWG 17)]	3/ 9.84	VW3M5102R30	1.070/ 2.359
	BMH1403P				5/ 16.40	VW3M5102R50	1.670/ 3.682
					10/ 32.81	VW3M5102R100	3.210/ 7.077
					15/ 49.21	VW3M5102R150	4.760/ 10.494
					20/ 65.62	VW3M5102R200	6.300/ 13.889
		25/ 82.02	VW3M5102R250		7.945/ 17.516		
		50/ 164.04	VW3M5102R500		16.170/ 35.649		
		75/ 246.06	VW3M5102R750		24.095/ 53.120		

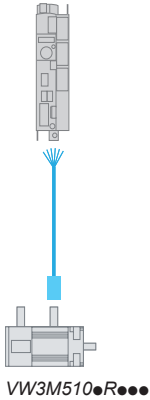

(1) IP 67 conformity kit sold by Festo AG under reference QSML-B-M3-4-20.

Connection components (continued)										
Power cordsets										
Description	From servo motor	To servo drive	Composition	Length	Reference	Weight				
				m/ft		kg/lb				
Cordsets equipped with one M40 industrial connector (servo motor end)										
E type mounting with open cable ducts, conforming to standard EN 60204-1										
BMH1901P	LXM32●D72N4, LXM32MD85N4, LXM32MC10N4		[(4 x 4 mm ² / AWG 12) + (2 x 1 mm ² / AWG 17)]	3/ 9.84	VW3M5103R30	2.000/ 4.409				
				5/ 16.40	VW3M5103R50	3.400/ 7.496				
				10/ 32.81	VW3M5103R100	6.500/ 14.330				
				15/ 49.21	VW3M5103R150	9.500/ 20.944				
				20/ 65.62	VW3M5103R200	12.100/ 26.676				
				25/ 82.02	VW3M5103R250	15.500/ 34.172				
				50/ 164.04	VW3M5103R500	30.300/ 66.800				
				75/ 246.06	VW3M5103R750	45.000/ 99.208				
				BMH1902P BMH1903P	LXM32●D72N4, LXM32MD85N4, LXM32MC10N4		[(4 x 6 mm ² / AWG 10) + (2 x 1 mm ² / AWG 17)]	3/ 9.84	VW3M5105R30	2.000/ 4.409
								5/ 16.40	VW3M5105R50	3.400/ 7.496
								10/ 32.81	VW3M5105R100	6.500/ 14.330
								15/ 49.21	VW3M5105R150	9.500/ 20.944
								20/ 65.62	VW3M5105R200	12.100/ 26.676
								25/ 82.02	VW3M5105R250	15.500/ 34.172
50/ 164.04	VW3M5105R500	30.300/ 66.800								
75/ 246.06	VW3M5105R750	45.000/ 99.208								
B2 type mounting, in conduits or distribution trunking, conforming to standard EN 60204-1										
BMH1901P	LXM32●D72N4, LXM32MD85N4, LXM32MC10N4		[(4 x 6 mm ² / AWG 10) + (2 x 1 mm ² / AWG 17)]					3/ 9.84	VW3M5105R30	2.000/ 4.409
								5/ 16.40	VW3M5105R50	3.400/ 7.496
								10/ 32.81	VW3M5105R100	6.500/ 14.330
								15/ 49.21	VW3M5105R150	9.500/ 20.944
								20/ 65.62	VW3M5105R200	12.100/ 26.676
				25/ 82.02	VW3M5105R250	15.500/ 34.172				
				50/ 164.04	VW3M5105R500	30.300/ 66.800				
				75/ 246.06	VW3M5105R750	45.000/ 99.208				
				BMH1902P BMH1903P	LXM32●D72N4, LXM32MD85N4, LXM32MC10N4		[(4 x 10 mm ² / AWG 8) + (2 x 1 mm ² / AWG 17)]	3/ 9.84	VW3M5104R30	3.600/ 7.937
								5/ 16.40	VW3M5104R50	5.600/ 12.346
								10/ 32.81	VW3M5104R100	10.500/ 23.149
								15/ 49.21	VW3M5104R150	15.500/ 34.172
								20/ 65.62	VW3M5104R200	20.300/ 44.754
								25/ 82.02	VW3M5104R250	24.500/ 54.013
50/ 164.04	VW3M5104R500	49.700/ 109.570								
75/ 246.06	VW3M5104R750	74.200/ 163.583								



VW3M8102R●●●

Connection components (continued)						
Control cordsets						
Description	For use with	To servo drive	Composition	Length m/ft	Reference	Weight kg/lb
SinCos Hiperface® encoder cordsets equipped with an M23 industrial connector (servo motor end) and an RJ45 connector with 8 + 2 contacts (servo drive end)	BMH●●●●●	LXM32●●●●● See references on pages 8 and 9	[3 x (2 x 0.14 mm ² / AWG 26) + (2 x 0.34 mm ² / AWG 22)]	1.5/ 4.92	VW3M8102R15	0.400/ 0.882
				3/ 9.84	VW3M8102R30	0.500/ 1.102
				5/16.40	VW3M8102R50	0.600/ 1.323
				10/32.81	VW3M8102R100	0.900/ 1.984
				15/49.21	VW3M8102R150	1.100/ 2.425
				20/65.62	VW3M8102R200	1.400/ 3.086
25/82.02	VW3M8102R250	1.700/ 3.748				
50/164.04	VW3M8102R500	3.100/ 6.834				
75/246.06	VW3M8102R750	4.500/ 9.921				

Connectors for creating power and control cordsets							
Description	For use with	Sold in lots of	Item no.	For cable cross-section mm ² / AWG	Unit reference	Weight kg/lb	
M23 industrial connector for creating power cordsets	BMH070●●, BMH100●●, and BMH140●P servo motors	5	1	1.5 or 2.5/ 16 or 14	VW3M8215	0.350/ 0.772	
M40 industrial connector for creating power cordsets	BMH1901P (1) servo motors	5	1	4/12	VW3M8217	0.850/ 1.874	
	BMH1901P (2), BMH1902P (1) (2), BMH1903P (1) (2), and BMH1904P (2) servo motors	5	1	6 or 10/ 10 or 8	VW3M8218	0.850/ 1.874	
RJ45 connector with 8 + 2 contacts for creating control cordsets	LXM32●●●●● servo drives (CN3 connector)	5	2	–	VW3M2208	0.200/ 0.441	
M23 industrial connector for creating control cordsets	BMH●●●●● servo motors	5	3	–	VW3M8214	0.350/ 0.772	
Description	From servo motor	To servo drive	Composition	Item no.	Length m/ft	Reference	Weight kg/lb
Cables for creating power cordsets	BMH070●●	LXM32●●●●●	[[4 x 1.5 mm ² / AWG 16) + (2 x 1 mm ² / AWG 17)]	4	25/82.02	VW3M5301R250	5.550/ 328.08
	BMH100●●	See combinations on page 6			50/164.04	VW3M5301R500	11.100/ 24.471
	BMH1401P				100/328.08	VW3M5301R1000	22.200/ 48.943
	BMH1402P BMH1403P	LXM32●D72N4	[[4 x 2.5 mm ² / AWG 14) + (2 x 1 mm ² / AWG 17)]	4	25/82.02	VW3M5302R250	7.725/ 17.031
					50/164.04	VW3M5302R500	15.450/ 34.061
					100/328.08	VW3M5302R1000	30.900/ 68.123
	BMH1901P (1)	LXM32●D72N4, LXM32MD85N4, AWG 12) LXM32MC10N4 +	[[4 x 4 mm ² / AWG 12) + (2 x 1 mm ² / AWG 17)]	4	25/82.02	VW3M5303R250	9.900/ 21.826
					50/164.04	VW3M5303R500	19.800/ 43.651
					100/328.08	VW3M5303R1000	39.600/ 87.303
	BMH1901P (2) BMH1902P (1) BMH1903P (1) BMH1904P (2)	LXM32●D72N4, LXM32MD85N4, AWG 10) LXM32MC10N4 +	[[4 x 6 mm ² / AWG 10) + (2 x 1 mm ² / AWG 17)]	4	25/82.02	VW3M5305R250	14.750/ 32.518
					50/164.04	VW3M5305R500	29.500/ 65.036
					100/328.08	VW3M5305R1000	59.000/ 130.073
BMH1902P (2) BMH1903P (2) BMH1904P (2)	LXM32●D72N4, LXM32MD85N4, AWG 8) LXM32MC10N4 +	[[4 x 10 mm ² / AWG 8) + (2 x 1 mm ² / AWG 17)]	4	25/82.02	VW3M5304R250	24.500/ 54.013	
				50/164.04	VW3M5304R500	49.000/ 108.026	
				100/328.08	VW3M5304R1000	98.000/ 216.053	
Cables for creating control cordsets for SinCos Hiperface® encoders	BMH●●●●●	LXM32●●●●● See references on pages 8 and 9	[[3 x (2 x 0.14 mm ² / AWG 26) + (2 x 0.34 mm ² / AWG 22)]	5	25/82.02	VW3M8222R250	1.400/ 3.086
					50/164.04	VW3M8222R500	2.800/ 6.173
					100/328.08	VW3M8222R1000	5.600/ 12.346

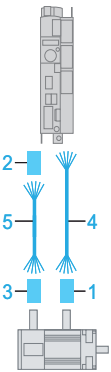

Connectors and cables for connecting the servo motor

(1) E type mounting with open cable ducts, conforming to standard EN 60204-1.
 (2) B2 type mounting in conduits or distribution trunking, conforming to standard EN 60204-1.

Lexium 32 and Motors

BMH servo motors

Option: Integrated holding brake

Option: Integrated encoder

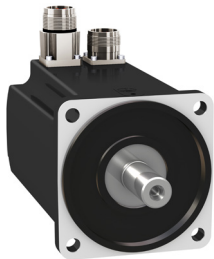
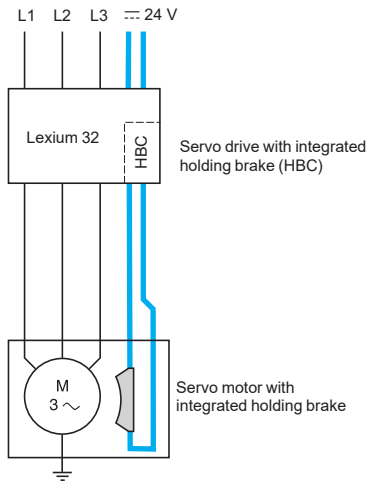

BMH servo motor

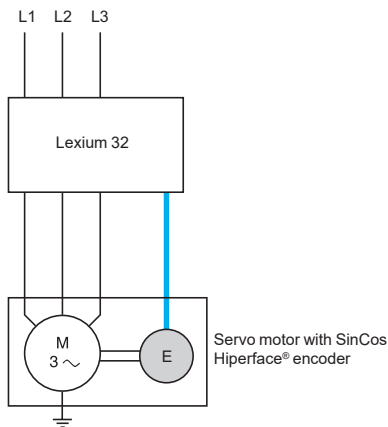

BMH servo motor

Holding brake

Presentation

The holding brake integrated in the BMH servo motor is an electromagnetic pressure spring brake that blocks the servo motor axis once the output current has been turned off.

In the event of an emergency, such as a power outage or an emergency stop, the drive is immobilized.

Blocking the servo motor axis is also necessary in cases of torque overload, such as in the event of vertical axis movement.

As standard, the Lexium 32 servo drive has a holding brake controller to amplify the braking control signal and help ensure the brake is deactivated quickly. The controller then reduces the control signal so as to decrease the power dissipated by the holding brake.

References

To select a BMH servo motor with or without holding brake, see the references on page 34.

For any additional information about holding brake characteristics, visit our website www.schneider-electric.com.

Integrated encoder in BMH servo motors

Presentation

The standard measurement device is the SinCos Hiperface® single-turn or multi-turn encoder integrated in BMH servo motors. This measurement device is particularly suited to the Lexium 32 range of servo drives.

Depending on the model, single-turn and multi-turn SinCos encoders are available with medium resolution and capacitive sensing, or high resolution and optical sensing.

Use of this interface enables:

- Automatic identification of BMH servo motor data by the servo drive
- Automatic initialization of the servo drive control loops, thus simplifying installation of the motion control device

References

To select the type of SinCos Hiperface® encoder integrated in the BMH servo motor (single-turn or multi-turn), see the references on page 34.

For any additional information about integrated encoder characteristics, visit our website www.schneider-electric.com.



BSH servo motor with rotatable angled connectors



BSH servo motor with straight connectors



BSH servo motor with rotatable angled connectors

Presentation

BSH servo motors offer an excellent solution to the need for high dynamic performance. With five flange sizes and a variety of lengths, there is a suitable solution for many applications, covering a continuous stall torque range from 0.5 to 33.4 Nm for speeds up to 9,000 rpm.

Thanks to their new winding technology based on salient poles, BSH servo motors are far more compact and offer a higher power density than conventional servo motors.

BSH servo motors are UL Recognized  and conform to standard UL1004 as well as to European directives (CE marking).

They are available with the following variants:

- 5 flange sizes: 40, 55, 70, 100, and 140 mm/1.57, 2.28, 2.76, 3.94, and 5.51 in.
- 2 degrees of protection for the shaft end: IP 50 or IP 65 in accordance with standard IEC/EN 60529. The degree of protection of the casing is IP 65 (IP 67 with the conformity kit, which is available as an option).
- With or without holding brake
- Straight or elbow connectors for power and encoder connection
- Integrated single-turn or multi-turn SinCos Hiperface® encoder (medium or high resolution)
- Smooth or keyed shaft end

Special features

BSH servo motors have been developed to comply with the following main specifications:

- Ambient operating temperature: - 20...+ 40 °C / - 4...+ 104 °F without derating, in accordance with standard IEC 60721-3-3, category 3K3, and up to 55 °C/131 °F with derating of 1% of the nominal output power per additional °C above 40 °C/104 °F.
- Maximum operating altitude: 1,000 m/3,280 ft without derating, 2,000 m/ 6,561 ft with k = 0.86, and 3,000 m/9,842 ft with k = 0.8 (1).
- The relative humidity that the servo motor can withstand is in line with standard IEC 60721-3-3, categories 3K3, 3Z12, and 3Z2.
- The windings are insulation class F (maximum temperature for windings 155 °C/ 311 °F) in accordance with standard IEC 60034-1.
- Mounting positions permitted: horizontal mounting (IMB5) or vertical mounting (IMV1 with shaft end at the top and IMV3 with shaft end at the bottom) in accordance with standard IEC 60034-7.

Sizing

The Lexium Sizer tool is available on our website www.schneider-electric.com to help you size your servo motor.

(1) k: derating factor

Presentation (continued)

Holding brake

BSH servo motors can be equipped with an electromagnetic holding brake.

⚠ Do not use the holding brake as a dynamic brake for deceleration, as this will quickly damage the brake.

Integrated encoder

BSH servo motors are equipped with a single-turn (131,072 points/turn) (1) or multi-turn (131,072 points/turn x 4,096 turns) (1) SinCos Hiperface® high-resolution absolute encoder giving an angular shaft position precise to less than ± 1.3 arc minutes.

This encoder performs the following functions:

- Gives the absolute position of the motor so that flows can be synchronized
- Measures the servo motor speed via the associated Lexium 32 servo drive (this information is used by the servo drive's speed controller)
- Measures the position information for the servo drive's position controller
- Sends data from the servo motor to the servo drive, which provides automatic identification of the motor when the servo drive starts

Description

BSH servo motors, with a 3-phase stator and a 6 to 10-pole rotor (depending on model) with Neodymium Iron Borium (NdFeB) magnets, consist of:

- 1 Casing with RAL 9005 opaque black paint protective coating
- 2 A 4-point axial mounting flange
- 3 A smooth or keyed shaft end (depending on the model)
- 4 A threaded sealed male straight connector for the power cable (2)
- 5 A threaded sealed male straight connector for the control cable (encoder) (2)

Cables and connectors to be ordered separately, for connection to Lexium 32 servo drives (see page 44).

Schneider Electric has taken particular care over the compatibility of BSH servo motors and Lexium 32 servo drives. This compatibility is only possible when using cables and connectors sold by Schneider Electric (see page 44).

(1) Encoder resolution given for use with a Lexium 32 servo drive.

(2) For other model with rotatable elbow connector, see page 43.

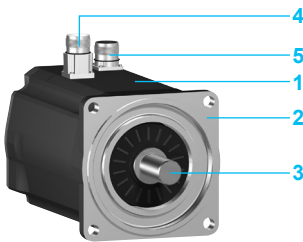

Lexium 32 and Motors

BSH servo motors

BSH servo motors

The BSH servo motors shown below are supplied without a gearbox.

For gearboxes, please consult "GBX and GBY planetary gearboxes" catalog or on our web site www.schneider-electric.com

Continuous stall torque	Peak stall torque	Nominal servo motor output power	Nominal speed	Maximum mechanical speed	Associated LXM32 servo drive	Reference (1)	Weight (2)
Nm	Nm	W	rpm	rpm			kg/lb
0.21	0.8	77	4,000	10,000	●U45M2	BSH0401P●●●●A	0.400/ 0.881
		166	9,000	10,000	●U60N4	BSH0401P●●●●A	0.400/ 0.881
0.38	1.37	152	4,000	10,000	●U45M2	BSH0402P●●●●A	0.600/ 1.322
		275	9,000	10,000	●U60N4	BSH0402P●●●●A	0.600/ 1.322
0.5	1.4	300	6,000	9,000	●U45M2	BSH0551T●●●●A	1.160/ 2.557
		150	3,000	9,000	●U90M2	BSH0551T●●●●A	1.160/ 2.557
	300	6,000	9,000	●U60N4	BSH0551P●●●●A	1.160/ 2.557	
0.8	1.9	250	3,000	9,000	●U45M2	BSH0552T●●●●A	1.470/ 3.241
		450	6,000	9,000	●U90M2	BSH0552T●●●●A	1.470/ 3.241
	400	6,000	9,000	●U60N4	BSH0552P●●●●A	1.470/ 3.241	
		6,000	9,000	●U60N4	BSH0553P●●●●A	1.760/ 3.880	
1.05	3.5	400	6,000	9,000	●U60N4	BSH0553P●●●●A	1.760/ 3.880
1.2	3	550	6,000	9,000	●U90M2	BSH0553T●●●●A	1.760/ 3.880
	3.3	350	3,000	9,000	●D18M2		
1.3	3.5	500	5,000	8,000	●U90M2	BSH0701T●●●●A	2.200/ 4.850
		350	2,500	8,000	●D18M2	BSH0701T●●●●A	2.200/ 4.850
1.4	3.5	350	2,500	8,000	●D18M2	BSH0701T●●●●A	2.200/ 4.850
		700	5,000	8,000	●D12N4	BSH0701P●●●●A	2.200/ 4.850
2.2	6.1	550	2,500	8,000	●D30M2	BSH0702T●●●●A	2.890/ 6.371
	7.2	950	5,000	8,000	●D18M2		
	7.6	850	5,000	8,000	●D12N4	BSH0702P●●●●A	2.890/ 6.371
2.6	7.4	900	4,000	8,000	●D18M2	BSH0703T●●●●A	3.620/ 7.981
2.7	7.5	900	4,000	6,000	●D18M2	BSH1001T●●●●A	4.200/ 9.259
3.1	11.3	1,300	5,000	8,000	●D18N4	BSH0703P●●●●A	3.620/ 7.981
3.3	6.3	700	2,500	6,000	●D30M2	BSH1001T●●●●A	4.200/ 9.259
		1,100	4,000	6,000	●D18N4	BSH1001P●●●●A	4.200/ 9.259
5.8	16.4	1,500	4,000	6,000	●D30M2	BSH1002T●●●●A	5.900/ 13.007
	18.3	1,700	4,000	6000	●D18N4	BSH1002P●●●●A	5.900/ 13.007
8	28.3	2,000	3,000	6,000	●D30N4	BSH1003P●●●●A	7.400/ 16.314
		2,600	4,000	6,000	●D30N4	BSH1003P●●●●A	7.400/ 16.314
10	37.9	2,100	2,500	6,000	●D30N4	BSH1004P●●●●A	9.500/ 20.944
		2,600	3,000	6,000	●D30N4	BSH1004P●●●●A	9.500/ 20.944
11.1	27	2,500	2,500	4,000	●D30N4	BSH1401P●●●●A	11.200/ 24.692
		3,000	3,000	4,000	●D30N4	BSH1401P●●●●A	11.200/ 24.692
19.5	59.3	3,900	3,000	4,000	●D72N4	BSH1402T●●●●P	16.000/ 35.274
27.8	90.2	4,100	3,000	4,000	●D72N4	BSH1403T●●●●P	21.200/ 48.738
		5,000	2,500	4,000	●D72N4	BSH1404P●●●●P	26.500/ 58.422

(1) To complete each reference see the table on page 43.

(2) Weight of servo motor without brake, no packaging. To obtain the weight of the servo motor with holding brake, please consult our website www.schneider-electric.com.

F19_MOT_CPF1R16001A



BSH040●●●●2A

105980



BSH055●●●●1A

105981



BSH070●●●●1A

105982



BSH100●●●●1A

105983



BSH1401P●●●1A

BSH servo motors (continued)					
To order a BSH servo motor, complete each reference with:					
eg: BSH0401P ● ● ● ● ●					
Shaft end	IP 50	Smooth	0		
		Keyed	1		
	IP 65/IP 67 (1)	Smooth	2		
		Keyed	3		
Integrated sensor	High resolution, optical	Single-turn, SinCos Hiperface® 131,072 points/turn, 128 Sin/Cos periods per revolution		1	
		Multi-turn, SinCos Hiperface® 131,072 points/turn x 4,096 turns, 128 Sin/Cos periods per revolution		2	
	Medium resolution, capacitive	Single-turn, SinCos Hiperface® 32768 points/turn, 16 Sin/Cos periods per revolution (2)		6	
		Multi-turn, SinCos Hiperface® 32768 points/turn x 4,096 turns, 16 Sin/Cos periods per revolution (2)		7	
Holding brake	Without			A	
	With			F	
Connections	Straight connectors				1
	Rotatable right angle elbow connectors				2
Flange	International standard				A or P (3)

Note: The example above is for a BSH0401P servo motor. For other servo motors, replace BSH0401P with the relevant reference.

Dimensions (overall)			
Servo motors	Flange	W x H x D (4)	
		Without holding brake	With holding brake
		mm/in.	mm/in.
BSH0401P●	40 x 40/ 1.57 x 1.57	40 x 73.4 x 98.4 1.57 x 2.88 x 3.87	40 x 99.4 x 124.4 1.57 x 3.91 x 4.89
BSH0402P●	40 x 40/ 1.57 x 1.57	40 x 93.4 x 118.4/ 1.57 x 3.67 x 4.66	40 x 119.4 x 144.4/ 1.57 x 4.70 x 5.68
BSH0551●	55 x 55/ 2.16 x 2.16	55 x 94.5 x 132.5/ 2.16 x 3.72 x 5.22	55 x 94.5 x 159/ 2.16 x 3.72 x 6.26
BSH0552●	55 x 55/ 2.16 x 2.16	55 x 94.5 x 154.5/ 2.16 x 3.72 x 6.08	55 x 94.5 x 181/ 2.16 x 3.72 x 7.13
BSH0553●	55 x 55/ 2.16 x 2.16	55 x 94.5 x 176.5/ 2.16 x 3.72 x 6.95	55 x 94.5 x 203/ 2.16 x 3.72 x 7.99
BSH0701●	70 x 70/ 2.76 x 2.76	70 x 111.5 x 154/ 2.76 x 4.39 x 6.06	70 x 111.5 x 180/ 2.76 x 4.39 x 7.09
BSH0702●	70 x 70/ 2.76 x 2.76	70 x 111.5 x 187/ 2.76 x 4.39 x 7.36	70 x 111.5 x 213/ 2.76 x 4.39 x 8.39
BSH0703●	70 x 70/ 2.76 x 2.76	70 x 111.5 x 220/ 2.76 x 4.39 x 8.66	70 x 111.5 x 254/ 2.76 x 4.39 x 10.00
BSH1001●	100 x 100/ 3.94 x 3.94	100 x 138.5 x 169/ 3.94 x 5.45 x 6.65	100 x 138.5 x 200/ 3.94 x 5.45 x 7.87
BSH1002●	100 x 100/ 3.94 x 3.94	100 x 138.5 x 205/ 3.94 x 5.45 x 8.07	100 x 138.5 x 236/ 3.94 x 5.45 x 9.29
BSH1003●	100 x 100/ 3.94 x 3.94	100 x 138.5 x 241/ 3.94 x 5.45 x 9.49	100 x 138.5 x 272/ 3.94 x 5.45 x 10.71
BSH1004●	100 x 100/ 3.94 x 3.94	100 x 138.5 x 277/ 3.94 x 5.45 x 10.91	100 x 138.5 x 308/ 3.94 x 5.45 x 12.13
BSH1401●	140 x 140/ 5.51 x 5.51	140 x 178 x 218/ 5.51 x 7.01 x 8.58	140 x 178 x 256/ 5.51 x 7.01 x 10.08
BSH1402●	140 x 140/ 5.51 x 5.51	140 x 192.5 (5) x 273/ 5.51 x 7.58 (5) x 10.75	140 x 192.5 (5) x 311/ 5.51 x 7.58 (5) x 12.24
BSH1403●	140 x 140/ 5.51 x 5.51	140 x 192.5 (5) x 328/ 5.51 x 7.58 (5) x 12.91	140 x 192.5 (5) x 366/ 5.51 x 7.58 (5) x 14.41
BSH1404●	140 x 140/ 5.51 x 5.51	140 x 192.5 (5) x 383/ 5.51 x 7.58 (5) x 15.08	140 x 192.5 (5) x 421/ 5.51 x 7.58 (5) x 16.58

(1) IP 67 with the VW3M230● IP 67 conformity kit supplied as an option (see page 44).

(2) Only available for BSH040●●●.

(3) "A" or "P" depending on the model (see table of references on page 42).

(4) D = motor length (excluding shaft end).

(5) 192.5 mm/7.58 in. with straight connector, 198.5 mm/7.82 in. with rotatable elbow connector.

Lexium 32 and Motors

BSH servo motors

IP 67 conformity kits

Connection components

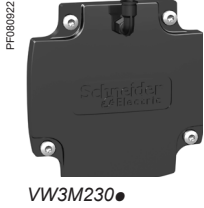

BSH servo motors (continued)

IP 67 conformity kits

This kit can be used to provide IP 67 degree of protection. It is mounted in place of the motor backplate.

Description	For use with	Reference	Weight kg/lb
IP 67 conformity kits (supplied as an option)	BSH055●●	VW3M2305 (1)	0.050/ 0.110
		VW3M2300 (2)	0.050/ 0.110
	BSH070●●	VW3M2306 (1)	0.100/ 0.220
		VW3M2301 (2)	0.100/ 0.220
	BSH100●●	VW3M2307 (1)	0.150/ 0.331
		VW3M2302 (2)	0.150/ 0.331
BSH140●●	VW3M2308 (1)	0.300/ 0.661	
	VW3M2303 (2)	0.300/ 0.661	

Connection components

Power cordsets

Description	From servo motor	To servo drive	Composition	Length	Reference	Weight	
				m/ft			kg/lb
Cordsets equipped with one ytec industrial connector (servo motor end)	BSH040●P●●	LXM32●●●●●●●● See combinations page 6	[(4 x 1 mm ² / AWG 17) + (2 x 0.75 mm ² / AWG 18)]	3/	VW3M5100R30	0.810/	
				9.84		1.786	
				5/		VW3M5100R50	1.210/
				16.40		2.668	
				10/		VW3M5100R100	2.290/
				32.81		5.049	
15/	VW3M5100R150	3.400/					
49.21	7.496						
25/82.02	VW3M5100R250	6.200/					
		13.669					
Cordsets equipped with one M23 industrial connector (servo motor end)	BSH055●● BSH070●● BSH100●● BSH1401P	LXM32●●●●●●●● See combinations page 6	[(4 x 1.5 mm ² / AWG 16) + (2 x 1 mm ² / AWG 17)]	1.5/	VW3M5101R15	0.600/	
				4.92		1.323	
				3/		VW3M5101R30	0.810/
				9.84		1.786	
				5/		VW3M5101R50	1.210/
				16.40		2.668	
				10/		VW3M5101R100	2.290/
				32.81		5.049	
				15/		VW3M5101R150	3.400/
				49.21		7.496	
				20/		VW3M5101R200	4.510/
				65.62		9.943	
				25/		VW3M5101R250	6.200/
				82.02		13.669	
50/	VW3M5101R500	12.325/					
164.04	27.172						
75/	VW3M5101R750	18.450/					
246.06	40.675						
Cordsets equipped with one M40 industrial connector (servo motor end)	BSH1402T BSH1403T BSH1404P	LXM32●D72N4	[(4 x 4 mm ² / AWG 12) + (2 x 1 mm ² / AWG 17)]	3/	VW3M5103R30	1.330/	
				9.84		2.932	
				5/		VW3M5103R50	2.130/
				16.40		4.696	
				10/		VW3M5103R100	4.130/
				32.81		9.105	
				15/		VW3M5103R150	6.120/
				49.21		13.492	
				20/		VW3M5103R200	8.090/
				65.62		17.835	
				25/		VW3M5103R250	11.625/
82.02	25.629						
50/	VW3M5103R500	23.175/					
164.04	51.092						
75/	VW3M5103R750	34.725/					
246.06	76.555						

(1) For a RS01 hardware version BSH motor. The version number is visible on the motor nameplate. For further information, please contact our Customer Care Centre.

(2) For a RS02 hardware version BSH motor. The version number is visible on the motor nameplate. For further information, please contact our Customer Care Centre.

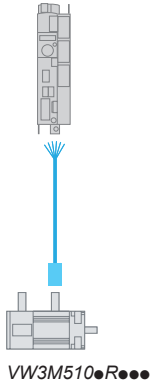

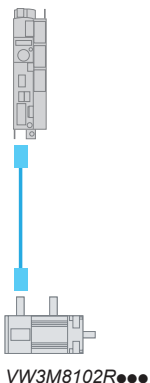

Connection components (continued)

Control cordsets

Description	From servo motor	To servo drive	Composition	Length		Reference	Weight	
				m/ft			kg/lb	
SinCos Hiperface® encoder cordsets equipped with an M23 industrial connector (servo motor end) and an RJ45 connector with 8+2 contacts (servo drive end)	BSH●●●●●	LXM32●●●●● See references pages 8 and 9	[3 x (2 x 0.14 mm ² /AWG 26) + (2 x 0.34 mm ² /AWG 22)]	1.5/		VW3M8102R15	0.400/	
				4.92			0.882	
				3/		VW3M8102R30	0.500/	
				9.84			1.102	
				5/		VW3M8102R50	0.600/	
				16.40			1.323	
				10/		VW3M8102R100	0.900/	
				32.81			1.984	
				15/		VW3M8102R150	1.100/	
				49.21			2.425	
20/		VW3M8102R200	1.400/					
65.62			3.086					
25/		VW3M8102R250	1.700/					
82.02			3.748					
50/		VW3M8102R500	3.100/					
164.04			6.834					
75/		VW3M8102R750	4.500/					
246.06			9.921					
SinCos Hiperface® encoder cordsets equipped with an ytec industrial connector (servo motor end) and an RJ45 connector with 8+2 contacts (servo drive end)	BSH040●P●●	LXM32●●●●● See references pages 8 and 9	[3 x (2 x 0.14 mm ² /AWG 26) + (2 x 0.34 mm ² /AWG 22)]	3/9.84		VW3M8100R30	0.500/	
							1.102	
				5/16.40		VW3M8100R50	0.600/	
							1.323	
				10/32.81		VW3M8100R100	0.900/	
		1.984						
15/49.21		VW3M8100R150	1.100/					
			2.425					
25/82.02		VW3M8100R250	1.700/					
			3.748					

Lexium 32 and Motors

BSH servo motors

Connection components

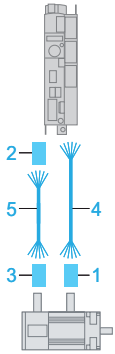

Connectors for creating power and control cordsets							
Description	For use with	For cable cross-section	Item no.	Unit reference	Weight		
		mm ² /AWG			kg/lb		
M23 industrial connector for creating power cordsets (sold in multiples of 5)	BSH055●●, BSH070●●, BSH100●●, and BSH1401P servo motors	1.5/16	1	VW3M8215	0.350/0.772		
M40 industrial connector for creating power cordsets (sold in multiples of 5)	BSH1402T, BSH1403T, and BSH1404P servo motors	4/12	1	VW3M8217	0.850/0.772		
ytec industrial connector for creating power cordsets (sold in multiples of 5)	BSH040●P●●	1/17	1	VW3M8219	0.350/0.772		
RJ45 connector with 8+2 contacts for creating control cordsets (sold in multiples of 5)	LXM32●●●●●● servo drives (CN3 connector)	–	2	VW3M2208	0.200/0.441		
M23 industrial connector for creating control cordsets (sold in multiples of 5)	BSH●●●●● servo motors	–	3	VW3M8214	0.350/0.772		
ytec industrial connector for creating control cordsets (sold in multiples of 5)	BSH040●P●●	–	3	VW3M8220	0.350/0.772		
Cables for creating power and control cordsets							
Description	From servo motor	To servo drive	Composition	Item no.	Length	Reference	Weight
					m/ft		kg/lb
Cables for creating power cordsets	BSH055●● BSH070●● BSH100●● BSH1401P	LXM32●●●●●● See combinations page 6	[(4 x 1.5 mm ² / AWG 16) + (2 x 1 mm ² / AWG 17)]	4	25/82.02	VW3M5301R250	5.550/12.125
					50/164.04	VW3M5301R500	11.100/24.471
					100/328.08	VW3M5301R1000	22.200/48.943
	BSH1402T BSH1403T BSH1404P	LXM32●D72N4	[(4 x 4 mm ² / AWG 12) + (2 x 1 mm ² / AWG 17)]	4	25/82.02	VW3M5303R250	9.900/21.826
					50/164.04	VW3M5303R500	19.800/43.651
					100/328.08	VW3M5303R1000	39.600/87.303
BSH040●P●●	LXM32●●●●●● See combinations page 6	[(4 x 1 mm ² / AWG 17) + (2 x 0.75 mm ² / AWG 18)]	4	100/328.08	VW3M5300R1000	22.200/48.943	
Cables for creating control cordsets for SinCos Hiperface® encoders	BSH●●●●●	LXM32●●●●●● See references pages 8 and 9	[3 x (2 x 0.14 mm ² / AWG 26) + (2 x 0.34 mm ² / AWG 22)]	5	25/82.02	VW3M8222R250	1.400/3.086
					50/164.04	VW3M8222R500	2.800/6.173
					100/328.08	VW3M8222R1000	5.600/12.346

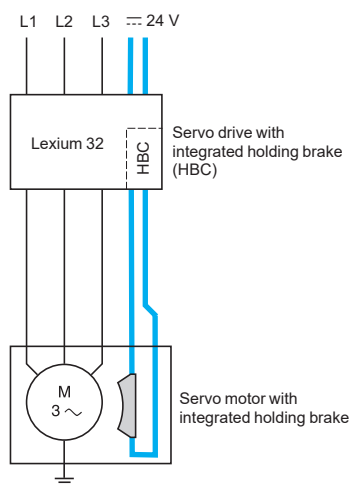

Holding brake

Presentation

The holding brake integrated in the BSH servo motor is an electromagnetic pressure spring brake that blocks the servo motor axis once the output current has been turned off.

In the event of an emergency, such as a power outage or an emergency stop, the drive is immobilized.

Blocking the servo motor axis is also necessary in cases of torque overload, such as in the event of vertical axis movement.

As standard, the Lexium 32 servo drive has a holding brake controller to amplify the braking control signal and help ensure the brake is deactivated quickly. The controller then reduces the control signal so as to decrease the power dissipated by the holding brake.

References

To select a BSH servo motor with or without holding brake, see the references on page 43.

For any additional information about holding brake characteristics, visit our website www.schneider-electric.com.

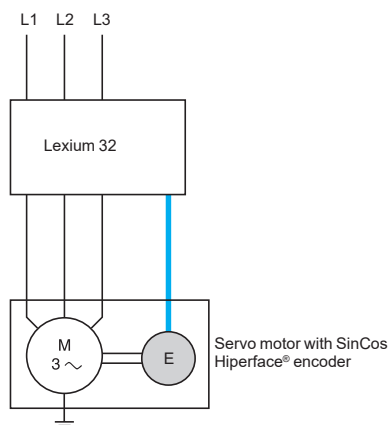

Integrated encoder in BSH servo motors

Presentation

The standard measurement device is the SinCos Hiperface® single-turn or multi-turn encoder integrated in BSH servo motors. This measurement device is particularly suited to the Lexium 32 range of servo drives.

Use of this interface enables:

- Automatic identification of BSH servo motor data by the servo drive
- Automatic initialization of the servo drive control loops, thus simplifying installation of the motion control device

References

To select the type of SinCos Hiperface® encoder integrated in the BSH servo motor (single-turn or multi-turn), see the references on page 43.

For any additional information about integrated encoder characteristics, visit our website www.schneider-electric.com.

4							
490NTC00005	18	LXM32SU45M2	8	VW3A7604R20	26	VW3M5100R100	44
	19	LXM32SU60N4	9	VW3A7604R30	26	VW3M5100R150	44
	20	LXM32SU90M2	8	VW3A7605R07	26	VW3M5100R250	44
	21			VW3A7605R20	26	VW3M5101R15	36
490NTC00005U	18	T					
	19	TCSCAR01NM120	15	VW3A7605R30	26	VW3M5101R30	36
	20		16	VW3A7606R07	26	VW3M5101R30	44
	21	TCSCAR013M120	13	VW3A7606R20	26	VW3M5101R50	36
490NTC00015	18		15	VW3A7606R30	26	VW3M5101R100	36
	19	TSXCANCA50	13	VW3A7607R07	26	VW3M5101R100	44
	20		15	VW3A7607R20	26	VW3M5101R150	36
	21		16	VW3A7607R30	26	VW3M5101R200	36
490NTW00002	18	TSXCANCA100	13	VW3A7608R07	26	VW3M5101R250	36
	19		15	VW3A7608R20	26	VW3M5101R500	36
	20		16	VW3A7608R30	26	VW3M5101R750	36
	21	TSXCANCA300	13	VW3A7733	26	VW3M5102R30	36
490NTW00002U	18		15	VW3A7734	26	VW3M5102R50	36
	19		16	VW3A8121	11	VW3M5102R100	36
	20	TSXCANCADD1	16	VW3A8126	11	VW3M5102R200	36
	21	TSXCANCADD03	16	VW3CANCARR1	13	VW3M5102R250	36
490NTW00005	18	TSXCANCADD3	16		15	VW3M5102R500	36
	19	TSXCANCADD5	16	VW3CANCARR03	13	VW3M5102R750	36
	20	TSXCANCB50	13		15	VW3M5103R30	37
	21		15	VW3CANTAP2	13	VW3M5103R50	37
490NTW00005U	18		16		15	VW3M5103R100	37
	19	TSXCANCB100	13	VW3E5001R005	12	VW3M5103R150	37
	20		15	VW3E5001R010	12	VW3M5103R200	37
	21		16	VW3E5001R015	12	VW3M5103R250	37
490NTW00012	18	TSXCANCB300	13	VW3E5001R020	12	VW3M5103R500	37
	19		15	VW3E5001R030	12	VW3M5104R30	37
	20		16	VW3E5001R050	12	VW3M5104R50	37
	21	TSXCANCBDD1	16	VW3E5001R100	12	VW3M5104R100	37
490NTW00012U	18	TSXCANCBDD03	16	VW3E5001R150	12	VW3M5104R150	37
	19	TSXCANCBDD3	16	VW3E5001R200	12	VW3M5104R200	37
	20	TSXCANCBDD5	16	VW3E5001R250	12	VW3M5104R250	37
	21	TSXCANCD50	13	VW3E5001R300	12	VW3M5104R500	37
			15	VW3E5001R400	12	VW3M5104R750	37
			16	VW3E5001R500	12	VW3M5105R30	37
		TSXCANCD100	13	VW3M2106	10	VW3M5105R50	37
			15	VW3M2201	12	VW3M5105R200	37
			16	VW3M2202	12	VW3M5105R250	37
		TSXCANCD300	13	VW3M2203	12	VW3M5105R500	37
			15	VW3M2207	12	VW3M5103R750	37
			16	VW3M2208	38	VW3M5104R30	37
		TSXCANKCDF90T	16		46	VW3M5104R50	37
		TSXCANKCDF90TP	16	VW3M2300	44	VW3M5104R100	37
		TSXCANKCDF180T	16	VW3M2301	36	VW3M5104R150	37
					44	VW3M5104R200	37
		V		VW3M2302	36	VW3M5104R250	37
		VW3A3601	19		44	VW3M5104R500	37
		VW3A3607	17	VW3M2303	36	VW3M5104R750	37
		VW3A3608	15		44	VW3M5105R30	37
		VW3A3616	18		44	VW3M5105R50	37
			21	VW3M2305	44	VW3M5105R200	37
		VW3A3618	16	VW3M2306	44	VW3M5105R250	37
		VW3A3628	15	VW3M2307	44	VW3M5105R500	37
		VW3A4420	29	VW3M2308	44	VW3M5105R100	37
		VW3A4421	29	VW3M2501	10	VW3M5105R150	37
		VW3A4422	29	VW3M2606	10	VW3M5105R200	37
		VW3A4423	29	VW3M3301	17	VW3M5105R250	37
		VW3A4424	29	VW3M3302	25	VW3M5105R500	37
		VW3A4553	27	VW3M3308	20	VW3M5105R750	37
		VW3A4554	27	VW3M3401	22	VW3M5300R1000	46
		VW3A4555	27	VW3M3402	22	VW3M5301R250	38
		VW3A7601R07	26	VW3M3403	22	VW3M5301R500	38
		VW3A7601R20	26	VW3M3501	24		46
		VW3A7601R30	26	VW3M3802	16	VW3M5301R1000	38
		VW3A7602R07	26	VW3M3805R010	13		46
		VW3A7602R20	26		15	VW3M5302R250	38
		VW3A7603R07	26	VW3M3805R030	13	VW3M5302R500	38
		VW3A7603R20	26		15	VW3M5302R1000	38
		VW3A7603R30	26	VW3M4701	22	VW3M5303R250	38
		VW3A7604R07	26	VW3M5100R30	44		46
				VW3M5100R50	44		46
						VW3M5303R500	38
						VW3M5303R1000	38
						VW3M5304R250	38
						VW3M5304R500	38
						VW3M5304R1000	38
						VW3M5305R250	38
						VW3M5305R500	38
						VW3M5305R1000	38
						VW3M7101R01	12
						VW3M7102R150	12
						VW3M8100R30	45
						VW3M8100R50	45
						VW3M8100R100	45
						VW3M8100R150	45
						VW3M8100R250	45
						VW3M8102R15	38
							45
						VW3M8102R30	38
							45
						VW3M8102R50	38
							45
						VW3M8102R100	38
							45
						VW3M8102R150	38
							45
						VW3M8102R200	38
							45
						VW3M8102R250	38
							45
						VW3M8102R500	38
							45
						VW3M8102R750	38
							45
						VW3M8111R10	12
						VW3M8112R10	12
						VW3M8214	38
							46
						VW3M8215	38
							46
						VW3M8217	38
							46
						VW3M8218	38
						VW3M8219	46
						VW3M8220	46
						VW3M8221R1000	22
						VW3M8222R250	38
							46
						VW3M8222R500	38
							46
						VW3M8222R1000	38
							46
						VW3M8223R30	12
						VW3M8502R03	12
						VW3M8502R15	12
						VW3M8704	11
						VW3M8705	11
						VW3M8801R30	24
						VW3M8802R15	24
						VW3M8802R30	24
						VW3M8810	24
						VW3M8820	24
						VZ1L007UM50	27
						VZ1L018UM20	27



[www.schneider-electric.com/Machine control solutions](http://www.schneider-electric.com/Machine%20control%20solutions)

Schneider Electric Industries SAS

Head Office
35, rue Joseph Monier
F-92500 Rueil-Malmaison
France

The information provided in this documentation contains general descriptions and/or technical characteristics of the performance of the products contained herein. This documentation is not intended as a substitute for and is not to be used for determining suitability or reliability of these products for specific user applications. It is the duty of any such user or integrator to perform the appropriate and complete risk analysis, evaluation and testing of the products with respect to the relevant specific application or use thereof. Neither Schneider Electric nor any of its affiliates or subsidiaries shall be responsible or liable for misuse of the information contained herein.

Design: Schneider Electric
Photos: Schneider Electric